

# **VOLMED**

Serving Healthcare Since 1971



## **GENERAL SURGICAL INSTRUMENTS CATALOG**

[www.volmed.co.uk](http://www.volmed.co.uk)

## About Us

With over 50 years of industry experience, VOLMED is a family-owned company specializing in the supply of high-quality surgical instruments to the medical and surgical markets across the United Kingdom, Europe, and globally. Our extensive expertise enables us to assist with project research and development, ensuring that we meet the evolving needs of our clients.

Our philosophy is simple: we treat our customers as we would like to be treated, which places customer satisfaction at the forefront of our priorities. This approach naturally aligns with our commitment to delivering products of the highest quality. Ultimately, our goal is to empower you to provide the best possible care and achieve improved health outcomes by streamlining the process of stocking your practice.

We take pride in the breadth of our product offerings, understanding that sourcing medical tools and surgical instruments from multiple suppliers can be both time-consuming and challenging. To address this, we strive to be your one-stop shop for all your requirements.

## Our History

Our story began over 50 years ago within a family deeply rooted in the medical instrument manufacturing industry. The foundation of our thriving business was built by a team of highly ambitious professionals with expertise in producing plastic surgery, dental and surgical instruments.

Inspired by the potential for excellence, our founder established VOLMED, a company dedicated to providing outstanding customer service and high-quality products. Since then, our team of dedicated professionals has worked tirelessly to ensure that customers worldwide receive only the finest surgical instruments and related services. We never compromise on quality, continually investing in our team, resources, equipment, and processes. Every detail is meticulously examined to ensure we can adapt to changing demands while maintaining the highest standards of quality.

## Our Promise

At VOLMED, our commitment to excellence is unwavering. We strive to achieve the highest standards in everything we do, working relentlessly to provide exceptional service to our customers and everyone associated with our company. We view it as our responsibility to contribute to a better future for the entire community, and we are dedicated to making this vision a reality.

## **Quality**

Our commitment to quality is reflected in our CE and UKCA-marked instruments, manufactured in accordance with stringent global quality assurance standards, including ISO 9001:2015, ISO 13485:2016, and the Medical Device Directive 93/42/EEC.

## **Our Mission**

We are committed to manufacturing and supplying products that meet the highest standards of strength, accuracy, and reliability. Recognizing the critical role our equipment plays in saving lives and improving health, we take this responsibility seriously. Our mission is to simplify the procurement process by offering a comprehensive range of high-quality surgical products under one roof.

## **Products**

At VOLMED, surgical instruments are at the core of our offerings. We provide a wide range of high-quality surgical products suitable for use in operating rooms, wards, veterinary practices, dentistry, and chiropody. Our instruments are crafted to strict standards using a blend of modern technology and traditional craftsmanship, in full compliance with the Medical Devices Directive 93/42/EEC. Complete traceability is maintained throughout the manufacturing process.

To ensure exceptional product performance and reliability, all our products undergo rigorous engineering analysis and stringent inspection methods. VOLMED instruments are guaranteed for five years against manufacturing defects and are made from premium surgical-grade stainless steel, in accordance with ISO 7153-1:2016 specifications. Explore our product listings and catalogues to discover our comprehensive range of surgical instruments.



Otology, Rhinology, Tonsil & Oral Instruments

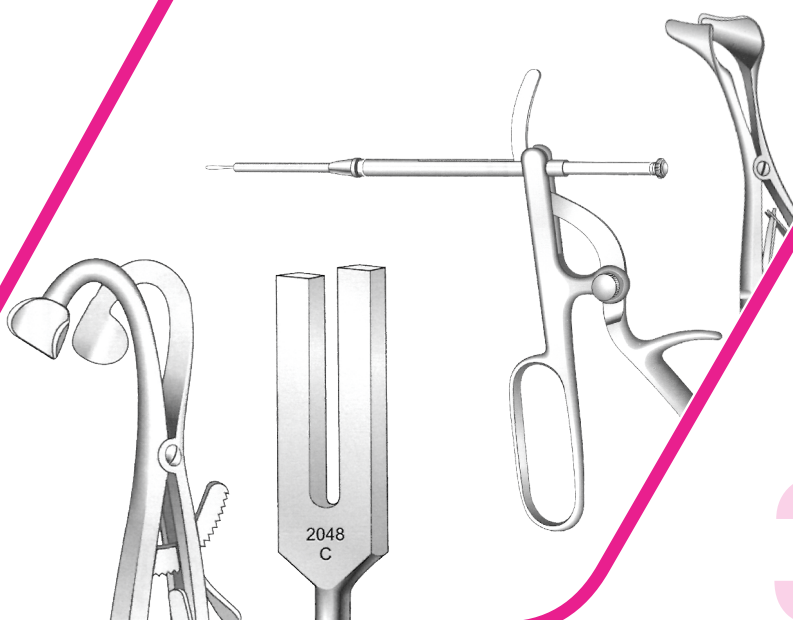
**VOLMED**

**VOLMED**

Serving Healthcare Since 1971

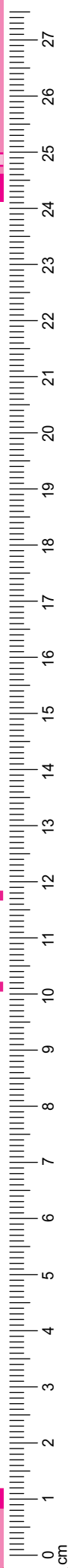
Otology  
Rhinology,  
Oral Instruments  
& Tonsil

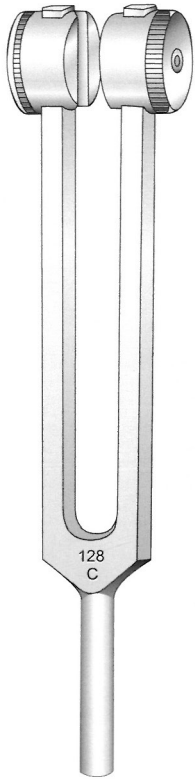
Serving Healthcare Since 1971



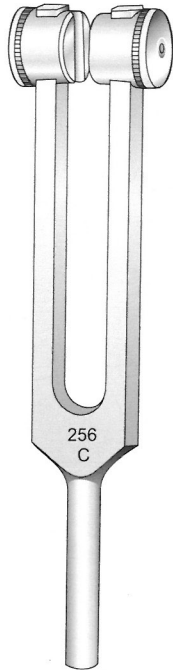
31

31  
32  
33  
34

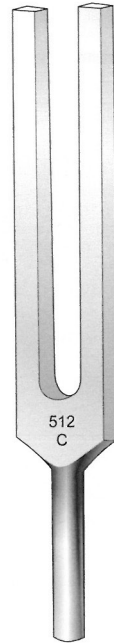




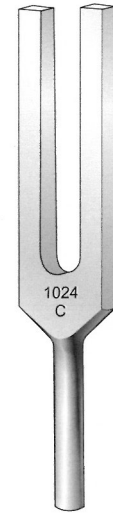
Surgicon-Alloy  
V-031-002  
C 128



Surgicon-Alloy  
V-031-003  
C<sup>1</sup> 256



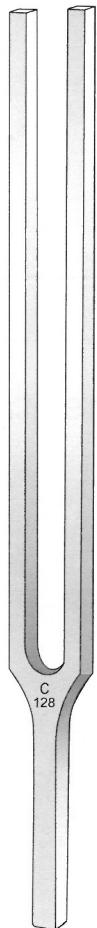
Surgicon-Alloy  
V-031-004  
C<sup>2</sup> 512



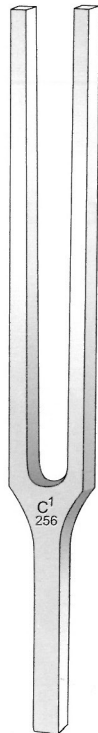
Surgicon-Alloy  
V-031-005  
C<sup>3</sup> 1024



Surgicon-Alloy  
V-031-006  
C<sup>4</sup> 2048



Hartmann  
V-031-007  
C 128



Hartmann  
V-031-008  
C<sup>1</sup> 256



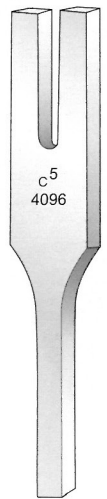
Hartmann  
V-031-009  
C<sup>2</sup> 512



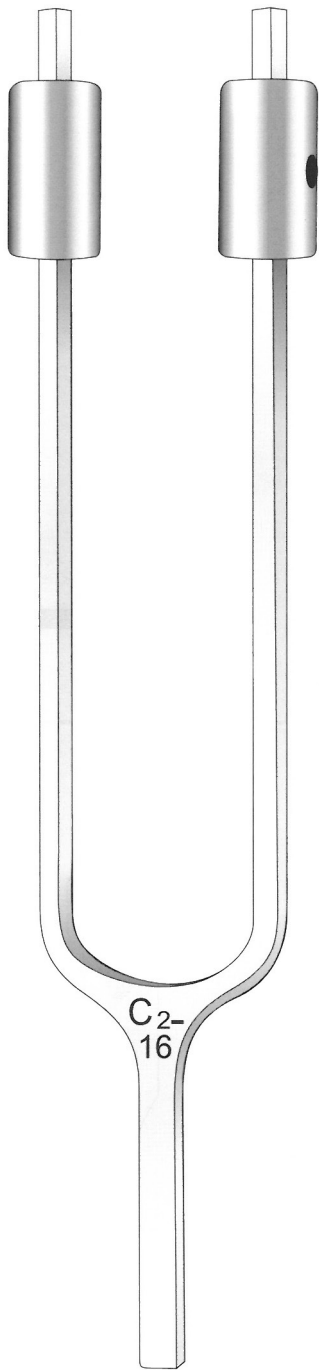
Hartmann  
V-031-011  
C<sup>3</sup> 1024



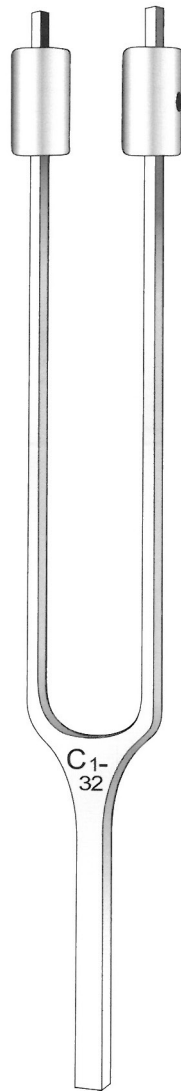
Hartmann  
V-031-012  
C<sup>4</sup> 2048



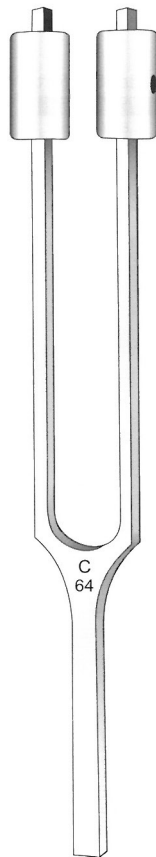
Hartmann  
V-031-013  
C<sup>5</sup> 4096



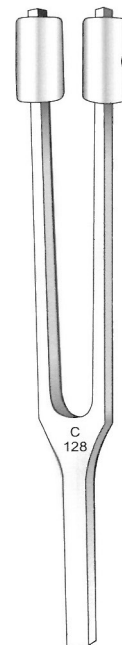
French  
V-031-021  
C, 16



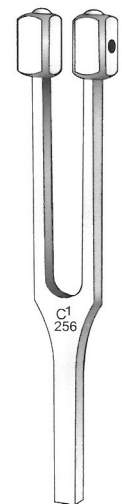
French  
V-031-022  
C, 32



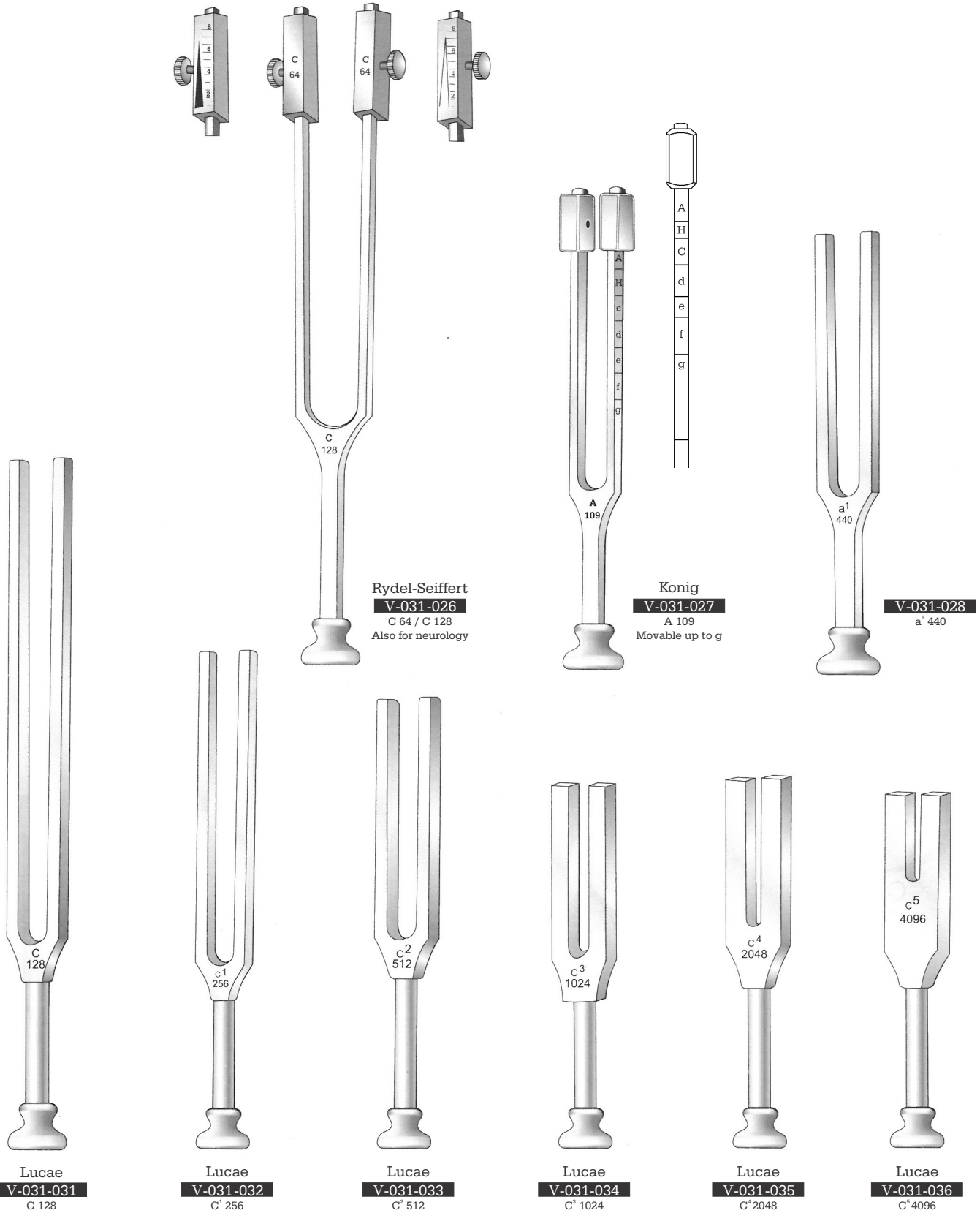
Hartmann  
V-031-023  
C 64



Hartmann  
V-031-024  
C 128

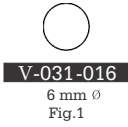


Hartmann  
V-031-025  
C' 256

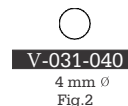
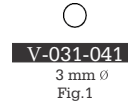




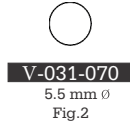
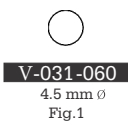
**Troeltsch**  
**V-031-015**  
 Set of 3



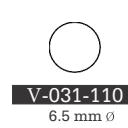
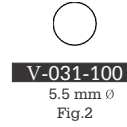
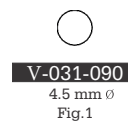
**Hartmann**  
**V-031-042**  
 Set of 5



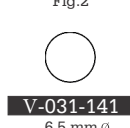
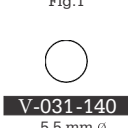
**Hartmann**  
**V-031-065**  
 Set of 4



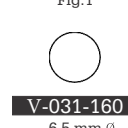
**Toynbee**  
**V-031-095**  
 Set of 4



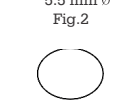
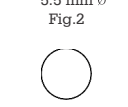
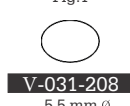
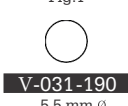
**Politzer**  
**V-031-125**  
 Set of 4



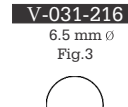
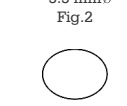
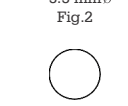
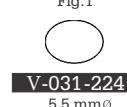
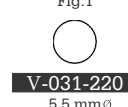
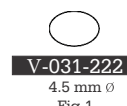
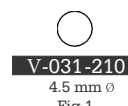
**Pritchard**  
**V-031-155**  
 Set of 3



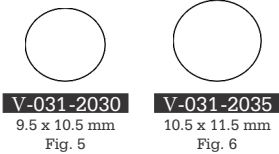
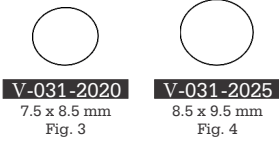
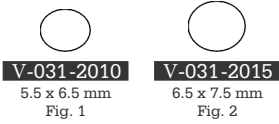
**Erhardt**  
**V-031-175** Round  
**V-031-205** Oval  
 Set of 3



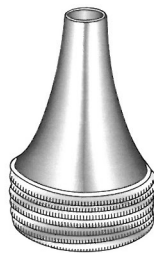
**Gruber**  
**V-031-212** Round  
**V-031-214** Oval  
 Set of 4



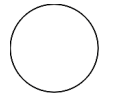
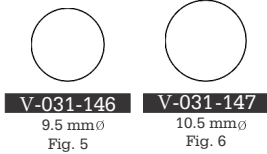
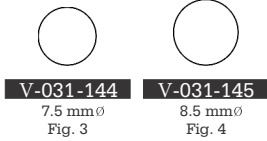
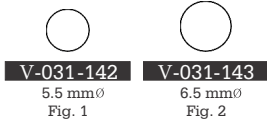




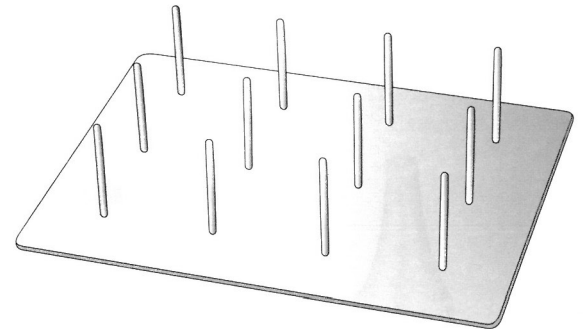
**Zollner**  
**V-031-2000**  
3.8 cm / 1½"  
Set of 6 pieces  
Oval, Black



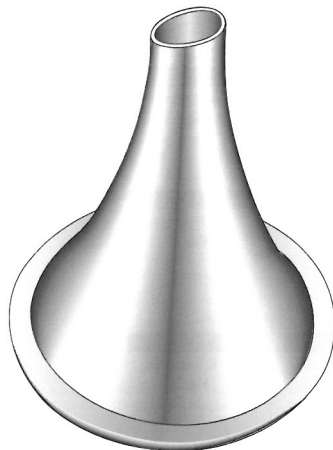
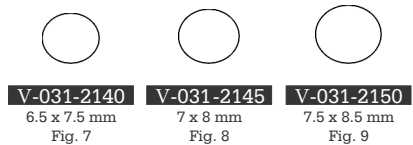
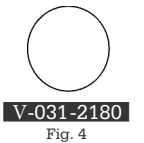
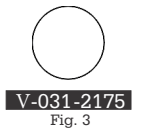
**Farrior**  
**V-031-149**  
3.6 cm / 1½"  
Set of 7 pieces  
Black



**V-031-148**  
11.5 mm $\varnothing$   
Fig. 7



**V-031-245**  
Ear specula storage rack



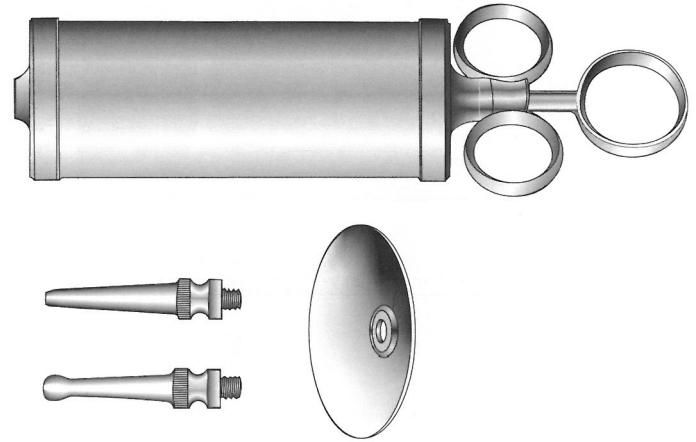
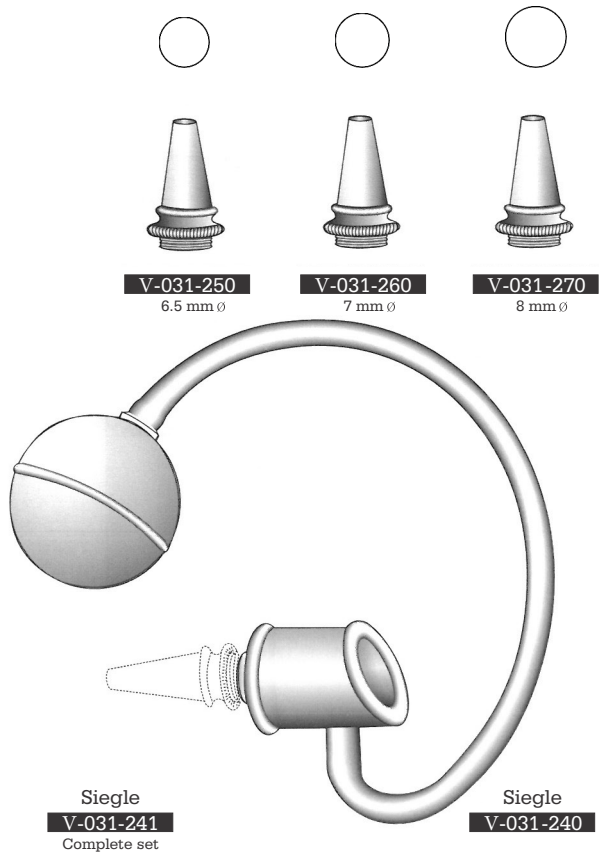
**Surgicon**  
**V-031-2100**  
Oval, angled end  
Set of 9 pieces



**Boucheron**  
**V-031-2160**  
Round  
Set of 4

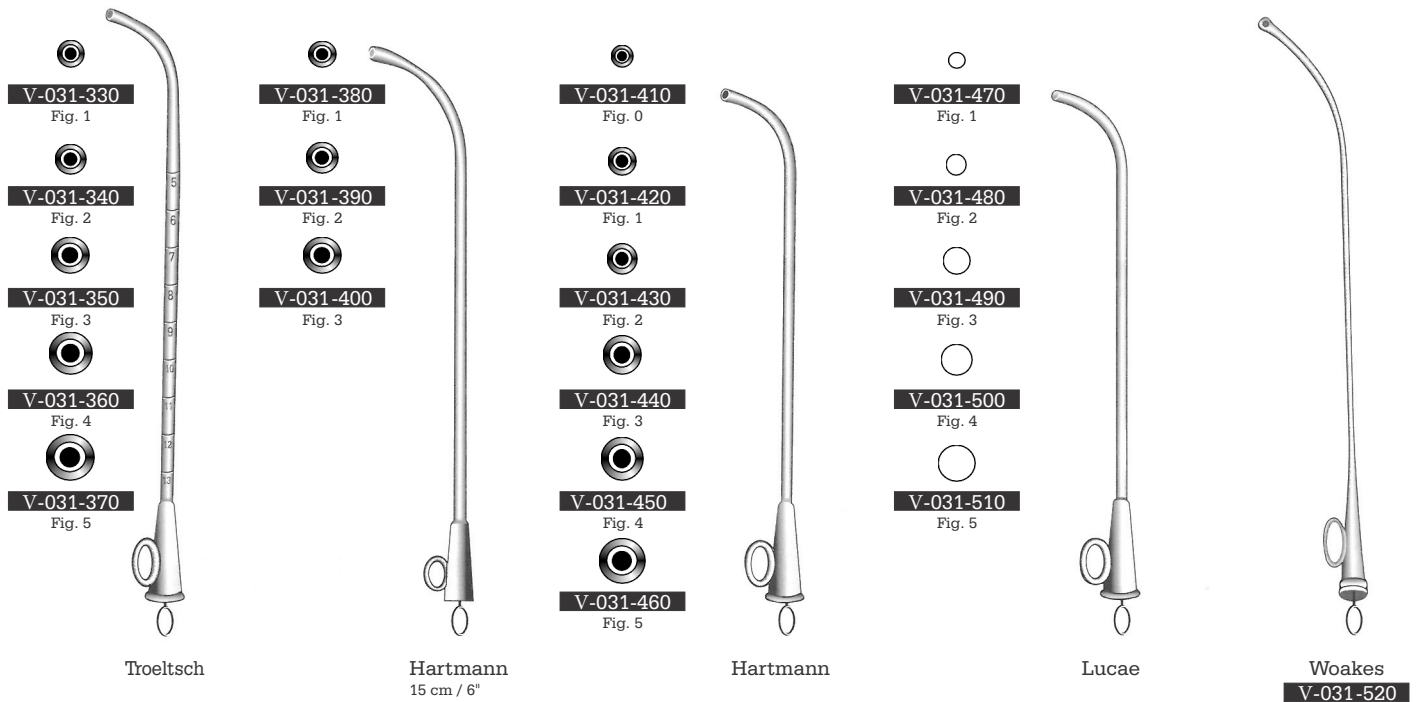
# Otology

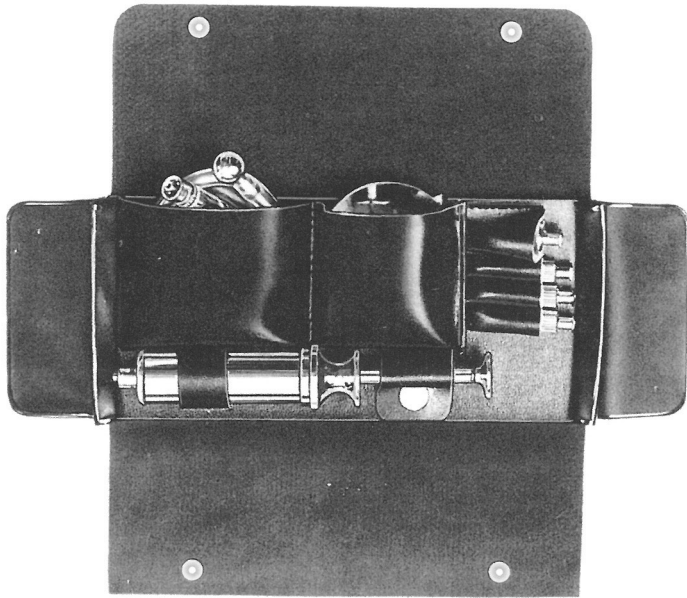
Specula and Syringes-Eustachian Catheters  
 Spekula und Spritzen-Ohrkatheter  
 Especulos y Jeringas Sondas auriculares



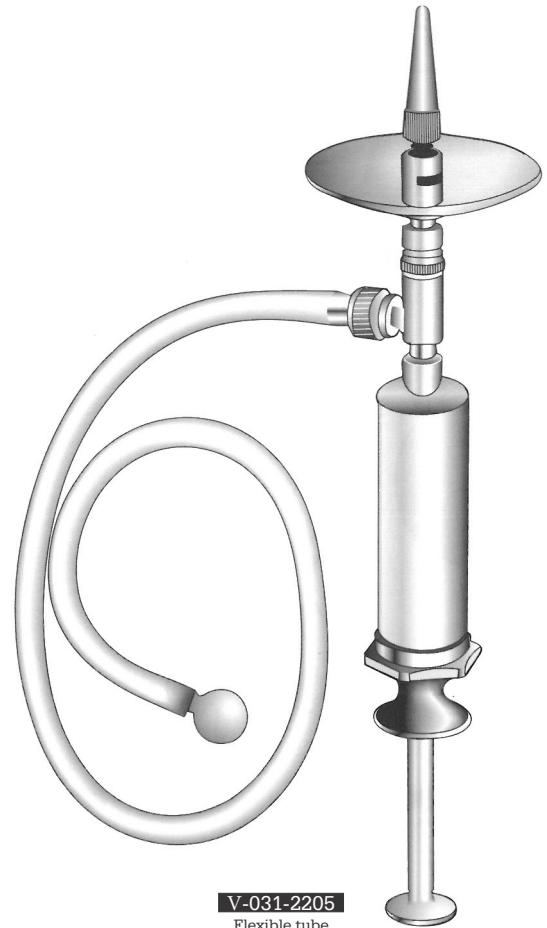
### Pimeroy

- V-031-280 50 c.c.
- V-031-290 75 c.c.
- V-031-300 100 c.c.
- V-031-310 150 c.c.
- V-031-320 200 c.c.

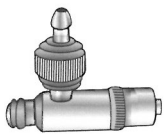




**V-031-2200**  
 Ear syringe, complete  
 self filling in plastic pouch



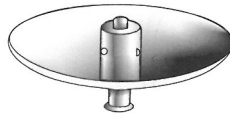
**V-031-2205**  
 Flexible tube



**V-031-2210**  
 Valve attachment



**V-031-2215**  
 Suction nozzle



**V-031-2220**  
 Protecting disc



**V-031-2225**  
 Metal olive



**V-031-2230**  
 Conical tip



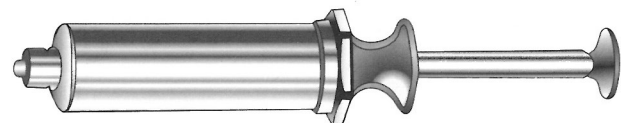
**V-031-2235**  
 Button ended tip



**V-031-2240**  
 Threaded tip



**V-031-2250** 50 ml  
**V-031-2260** 75 ml  
**V-031-2270** 100ml  
 Ear syringe, complete with  
 protecting disc and 2 tips

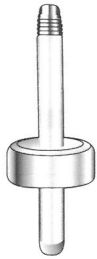


# Otology

Air Bags

Luftduschen

Insufladores de aire



**V-031-2305**  
Connecting nozzle



**V-031-2310**  
4 mm  $\varnothing$   
Ear olive



**V-031-2315**  
15 mm  $\varnothing$   
Nose olive



**V-031-2320**  
17 mm  $\varnothing$   
Nose olive



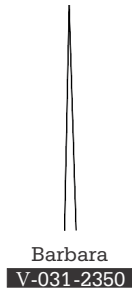
**V-031-2325**  
22 mm  $\varnothing$   
Nose olive



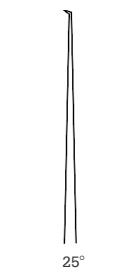
Poltzer  
**V-031-2300**  
**V-031-2301** Complete set



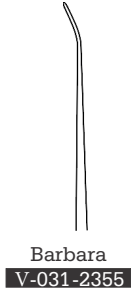
Barbara  
16 cm / 6 1/4"



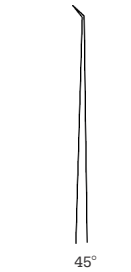
Barbara  
V-031-2350



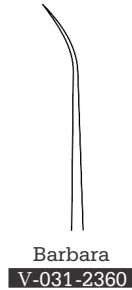
V-031-2370 0.3 mm  
 V-031-2372 0.6 mm  
 V-031-2374 1.0 mm



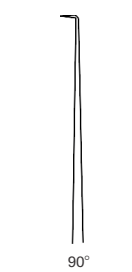
Barbara  
V-031-2355



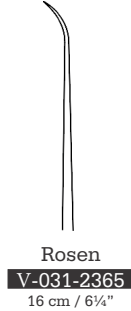
V-031-2390 0.3 mm  
 V-031-2392 0.6 mm  
 V-031-2394 1.0 mm  
 V-031-2396 1.2 mm  
 V-031-2398 1.5 mm  
 V-031-2400 2.0 mm  
 V-031-2402 2.5 mm



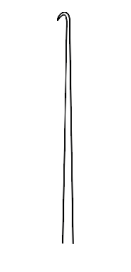
Barbara  
V-031-2360



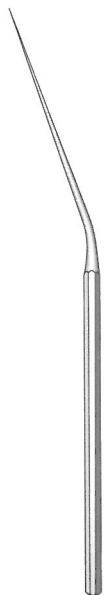
V-031-2410 0.3 mm  
 V-031-2412 0.6 mm  
 V-031-2414 1.0 mm  
 V-031-2416 1.2 mm  
 V-031-2418 1.5 mm  
 V-031-2420 2.0 mm  
 V-031-2422 2.5 mm



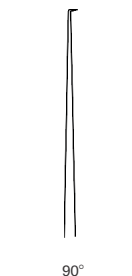
Rosen  
V-031-2365  
16 cm / 6 1/4"



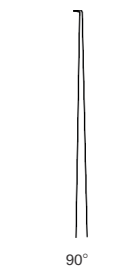
V-031-2430 0.5 mm  
 V-031-2432 1.0 mm



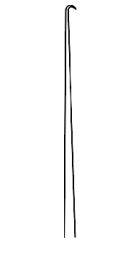
15.5 cm / 6"



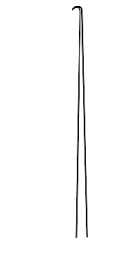
V-031-2440 0.3 mm  
 V-031-2442 0.6 mm  
 V-031-2444 1.0 mm



V-031-2450 0.3 mm  
 V-031-2452 0.6 mm  
 V-031-2454 1.0 mm



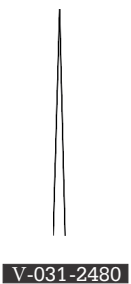
McGee  
V-031-2460 0.5 mm  
 V-031-2465 1.0 mm  
 For footplate



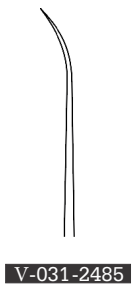
McGee  
V-031-2470 0.5 mm  
 V-031-2475 1.0 mm  
 For footplate



Barbara  
15.5 cm / 6"



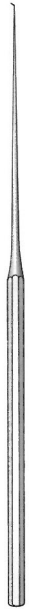
V-031-2480



V-031-2485

# Otology

Micro Ear Hooks, Micro Dissectors  
 Mikro Ohrhakchen, Mikro-Dissektoren  
 Micro ganchitos auriculares, Micro disecadores

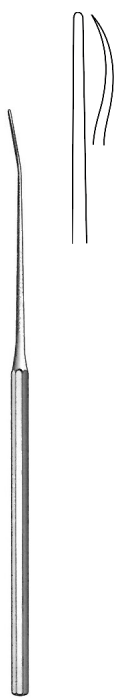


<b>V-031-2500</b> 0.3 mm	<b>V-031-2505</b> 0.6 mm	<b>Shambaugh</b> <b>V-031-2510</b> 1.0 mm		<b>V-031-2515</b> 0.3 mm	<b>V-031-2520</b> 0.6 mm	<b>Shambaugh</b> <b>V-031-2525</b> 1.0 mm		<b>Shea</b> <b>V-031-2530</b> 2.0 mm Exploring hook Blunt	<b>Austin</b> <b>V-031-2535</b> 3.0 mm Attic dissector Blunt



<b>V-031-2540</b> Angled to right	<b>V-031-2545</b> Angled to left
<b>V-031-2550</b> Angled to right	<b>V-031-2555</b> Angled to left

**Fisch**  
15.5 cm / 6"

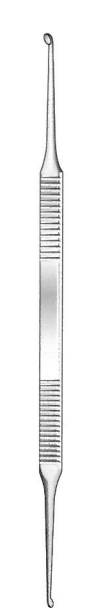


**Rosen**  
**V-031-2560**  
15.5 cm / 6"  
Micro ear periosteal elevator

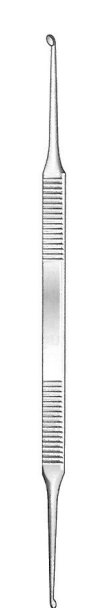
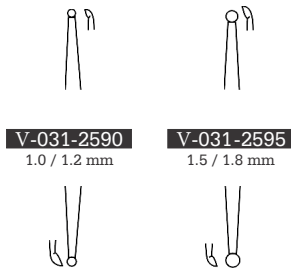


**House**  
15.5 cm / 6"  
Micro measuring rod

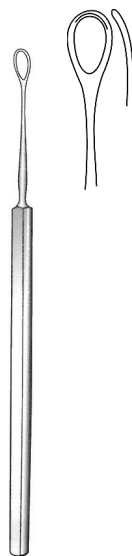
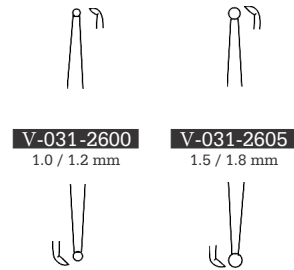
<b>V-031-2570</b> 3.5 mm	<b>V-031-2575</b> 4.0 mm
<b>V-031-2580</b> 4.5 mm	<b>V-031-2585</b> 5.0 mm



House  
14.5 cm / 5 3/4"



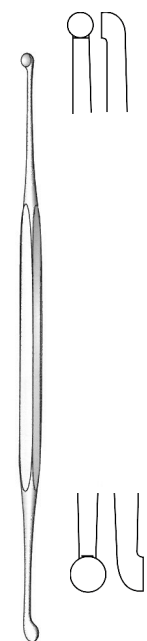
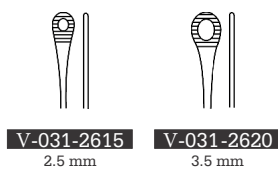
House  
14.5 cm / 5 3/4"



Langenbeck  
V-031-2610  
13 cm / 5"  
Blunt



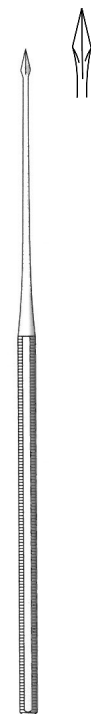
Shapleigh  
15 cm / 6"  
Ear curette  
Delicate



Jansen  
V-031-2630  
17 cm / 6 3/4"  
Sharp



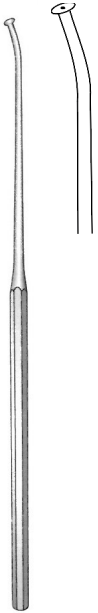
Poltzer  
V-031-2640  
14.5 cm / 5 3/4"  
Furuncle knife



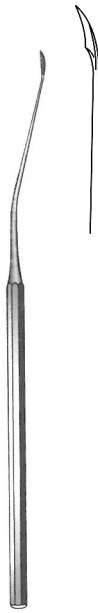
Poltzer  
V-031-2650  
17.5 cm / 7"

# Otology

Micro Ear Knives  
Mikro-Ohrmesser  
Micro cuchillos auriculares



Schuknecht  
V-031-2660  
Rotary knife



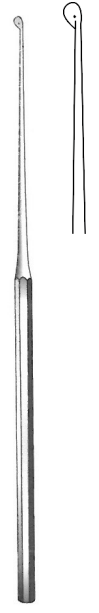
Schuknecht  
V-031-2670  
14.5 cm / 5 3/4"  
Sickle knife



Wullstein  
V-031-2680  
15.5 cm / 6"  
Sickle knife



Tabb  
V-031-2690  
Mucosa knife



Plester  
V-031-2700  
15 cm / 6"  
Flap knife



Rosen  
15 cm / 6"  
Circular cut knives



V-031-2710  
1 mm  $\emptyset$   
Fig. 7



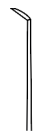
V-031-2715  
1.4 mm  $\emptyset$   
Fig. 6



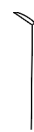
V-031-2720  
1.6 mm  $\emptyset$   
Fig. 5



V-031-2725  
2 mm  $\emptyset$   
Fig. 4



V-031-2730  
2.6 mm  $\emptyset$   
Fig. 3

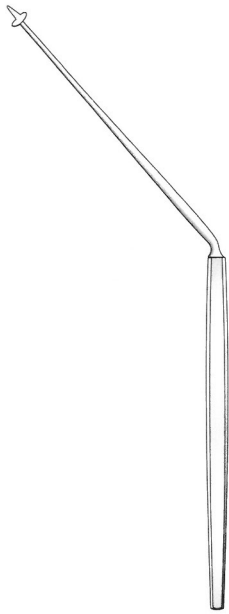


V-031-2735  
2.8 mm  $\emptyset$   
Fig. 2

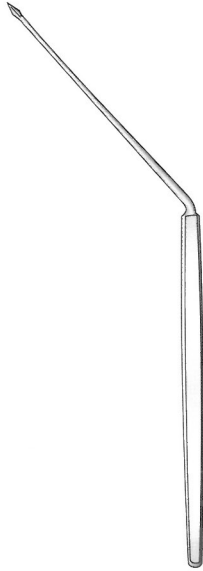


V-031-2740  
3 mm  $\emptyset$   
Fig. 1

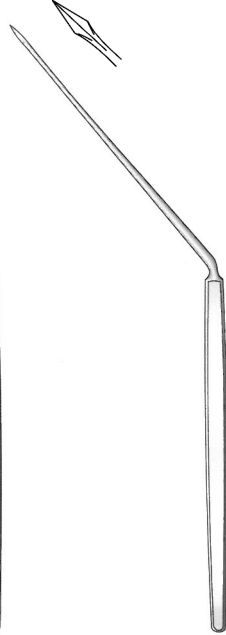




**Troeltsch**  
V-031-530  
18 cm / 7"



**Politzer**  
V-031-540  
16.5 cm / 6½"



**Politzer**  
V-031-550  
16.5 cm / 6½"  
Needle horizontaly



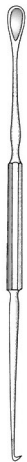
**Lucae**  
V-031-560  
18 cm / 7"



**Lucae**  
V-031-570  
18 cm / 7"



**Barker**  
V-031-580  
17 cm / 6¾"



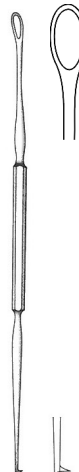
**Gross**  
V-031-590  
12 cm / 4¾"  
Blunt / Sharp



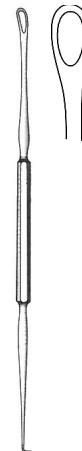
**Gross**  
V-031-600  
12 cm / 4¾"  
Blunt  
Ear scoop / hook



**Gross**  
V-031-610  
12 cm / 4¾"  
Blunt



**Gross**  
V-031-620  
12 cm / 4¾"  
Blunt / Sharp



**Gross**  
V-031-630  
12 cm / 4¾"



V-031-640  
2.75 mm



V-031-650  
3.75 mm



V-031-660  
5.5 mm



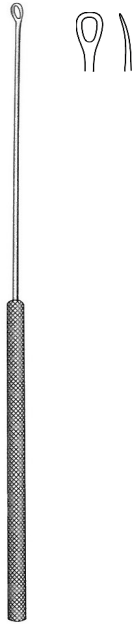
**Billeau**  
16.5 cm / 6½"  
Ear loop

# Otology

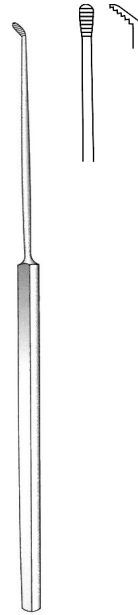
Foreign Body Instruments

Fremdkörperinstrumente

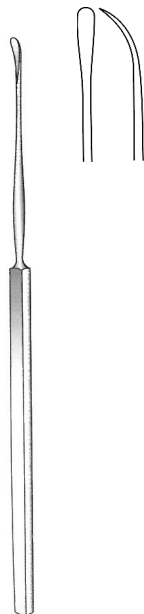
Instrumentos para cuerpos extraños



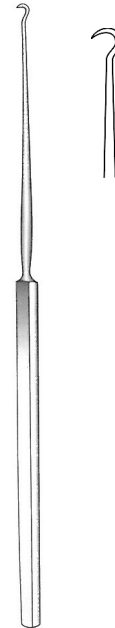
**Weber-Loch**  
**V-031-2760**  
16.5 cm / 6½"  
Ear loop



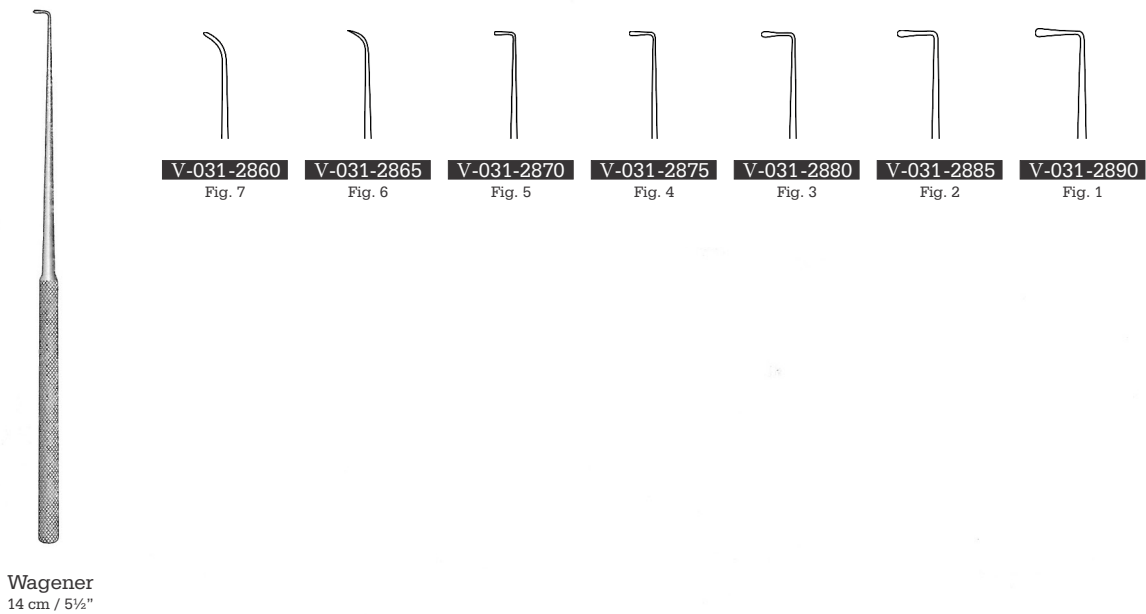
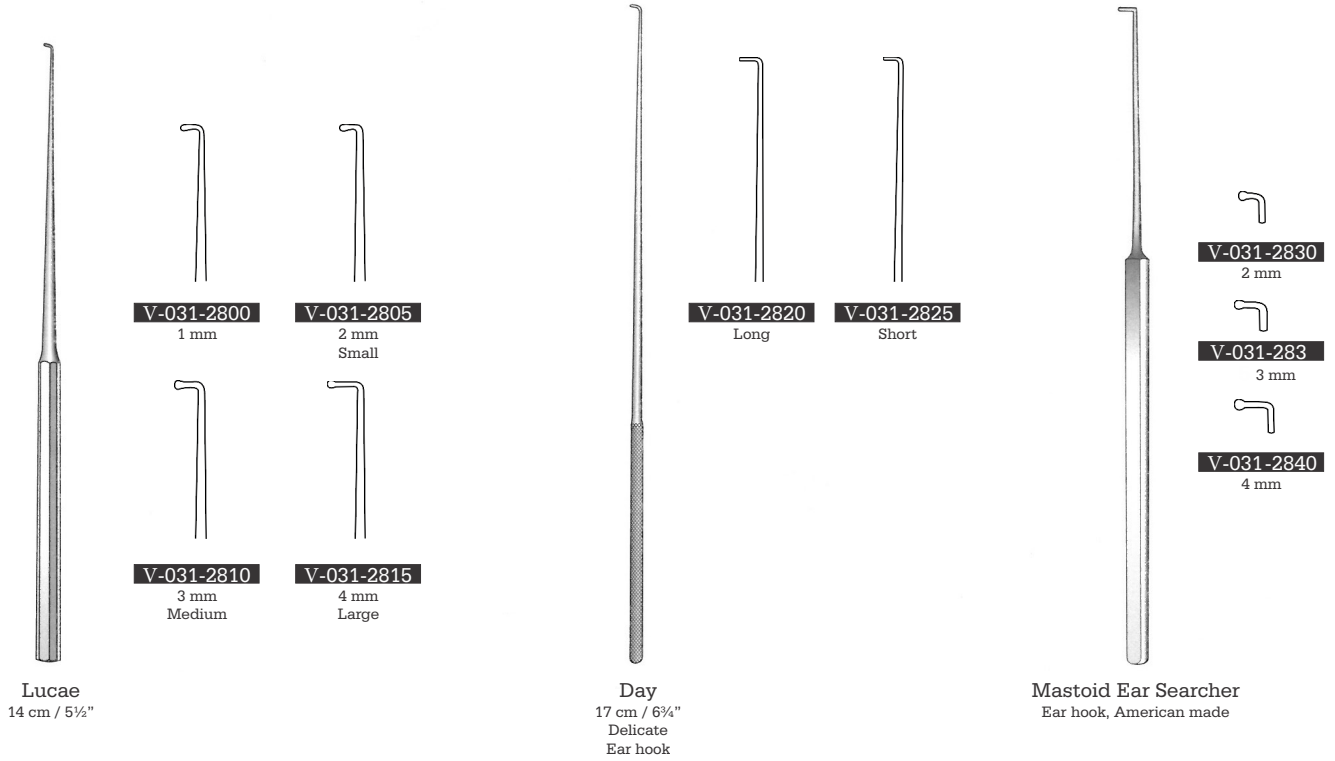
**Moldenhauer**  
**V-031-2770**  
15.5 cm / 6"  
Foreign body lever



**Zaufal**  
**V-031-2780**  
15 cm / 6"  
Foreign body lever



**Hartmann**  
**V-031-2790**  
16 cm / 6¼"  
Sharp, ear hooklet

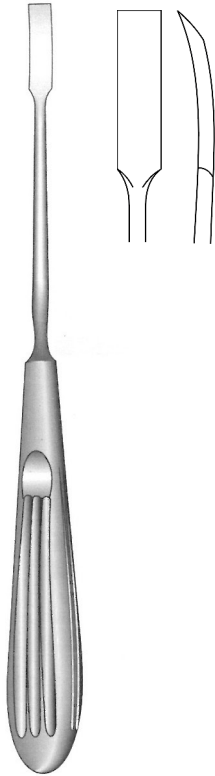


# Otology

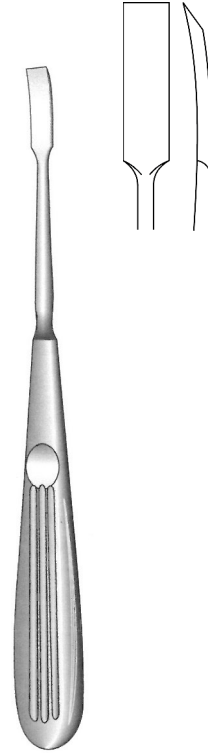
Ear Periosteal Elevators, Ear Scoops

Ohrspatzen, Ohrloeffel

Legras auriculares, Cucharillas auriculares



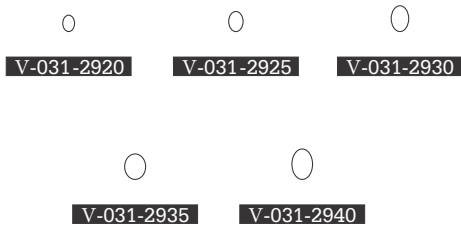
Lempert  
**V-031-2900**  
20.5 cm / 8"  
6 mm



Lempert  
**V-031-2910**  
18 cm / 7"  
6 mm



Lempert  
21.5 cm / 8½"  
Sharp





Blunt



Sharp



Fig. 000



Fig. 00



Fig. 0



Fig. 1

Blunt  
Sharp

V-031-670  
V-031-750

V-031-680  
V-031-760

V-031-690  
V-031-770

V-031-700  
V-031-780



Fig. 2



Fig. 3



Fig. 4



Fig. 5

Blunt  
Sharp

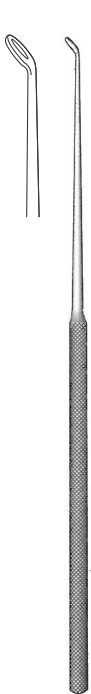
V-031-710  
V-031-790

V-031-720  
V-031-800

V-031-730  
V-031-810

V-031-740  
V-031-820

Buck  
16.5 cm / 6½"



- V-031-830 Fig. 000
- V-031-840 Fig. 00
- V-031-850 Fig. 0
- V-031-860 Fig. 1
- V-031-870 Fig. 2
- V-031-880 Fig. 3
- V-031-890 Fig. 4
- V-031-900 Fig. 5

Round handle  
Blunt



- V-031-910 Fig. 000
- V-031-920 Fig. 00
- V-031-930 Fig. 0
- V-031-940 Fig. 1
- V-031-950 Fig. 2
- V-031-960 Fig. 3
- V-031-970 Fig. 4
- V-031-980 Fig. 5

Round handle  
Sharp

Buck  
16.5 cm / 6½"  
extra extra fine



- V-031-831 Fig. 000
- V-031-841 Fig. 00
- V-031-851 Fig. 0
- V-031-861 Fig. 1
- V-031-871 Fig. 2
- V-031-881 Fig. 3
- V-031-891 Fig. 4
- V-031-901 Fig. 5

Octagonal handle  
Blunt



- V-031-911 Fig. 000
- V-031-921 Fig. 00
- V-031-931 Fig. 0
- V-031-941 Fig. 1
- V-031-951 Fig. 2
- V-031-961 Fig. 3
- V-031-971 Fig. 4
- V-031-981 Fig. 5

Octagonal handle  
Sharp

Buck  
16.5 cm / 6½"



V-032-1620



V-032-1630



V-032-1640



V-032-1650



V-032-1660

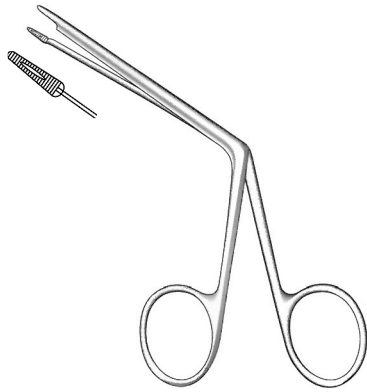
Myles  
17 cm / 6¾"

# Otology

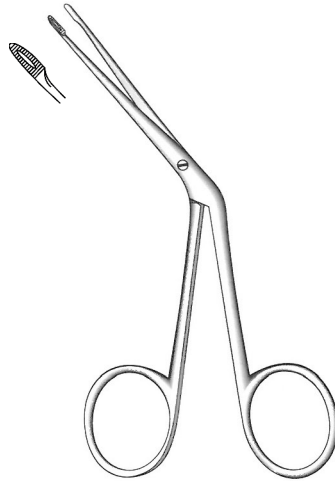
Ear Polypus Snare and Foreign Body Forceps

Polypenzangen, Fremdkörperheber

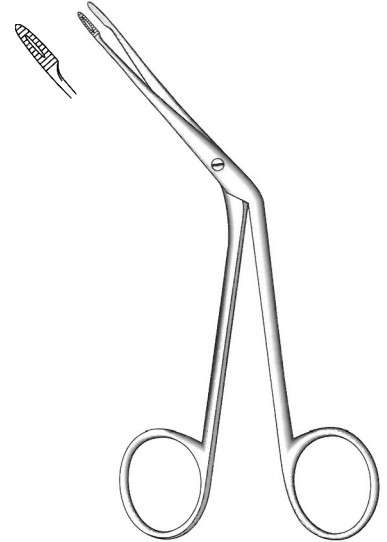
Pinzas para polipos, Elevadores para cuerpos extraños



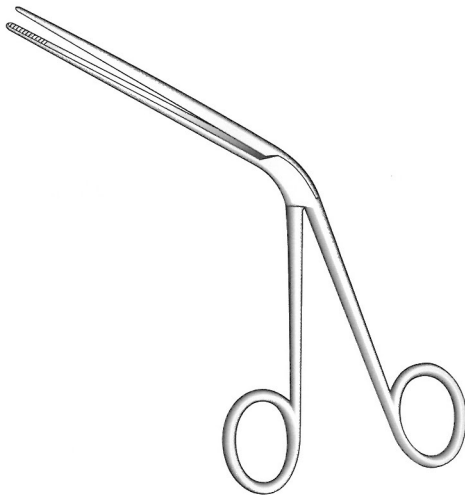
Littauer  
V-031-1120  
12 cm / 4 3/4"



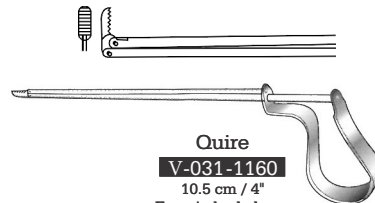
Hartmann  
V-031-1130  
12 cm / 4 3/4"  
Fine model



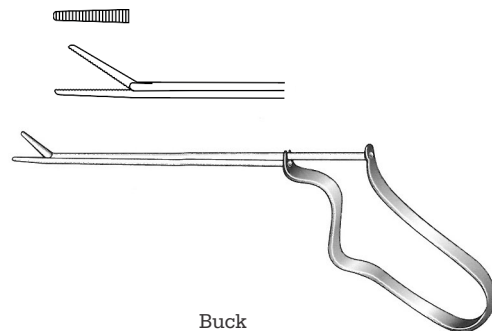
Hartmann  
V-031-1140  
14 cm / 5 1/2"  
Regular model



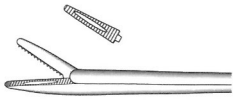
Tilley  
V-031-1150  
16.5 cm / 6 1/2"



Quire  
V-031-1160  
10.5 cm / 4"  
Foreign body lever



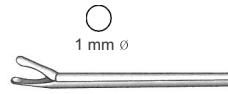
Buck  
V-031-1170  
11.5 cm / 4 1/2"  
Foreign body forceps



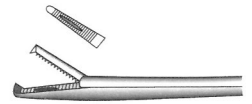
**Hartmann**  
**V-031-1180** 8.5 cm / 3½"  
**V-031-1182** 12 cm / 4¾"  
**V-031-1190** 14 cm / 5½"  
**V-031-1200** 16.5 cm / 6½"



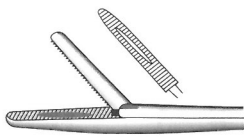
**Hartmann Wullstein**  
**V-031-1210**  
 8.5 cm / 3½"



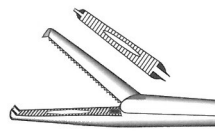
**Hartmann Wullstein**  
**V-031-1220**  
 8.5 cm / 3½"



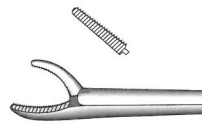
**Hartmann**  
**V-031-1230** 8.5 cm / 3½"  
**V-031-1232** 12 cm / 4¾"  
**V-031-1240** 14 cm / 5½"  
 1:2 Teeth



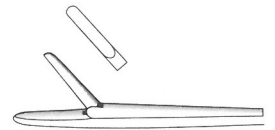
**Hartmann Noyes**  
**V-031-1250**  
 9 cm / 3½"



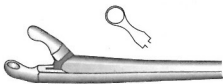
**Hartmann Noyes**  
**V-031-1260**  
 9 cm / 3½"  
 1:2 Teeth



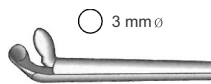
**Hartmann Weingartner**  
**V-031-1270**  
 8.5 cm / 3½"



**Hartmann**  
**V-031-1280**  
 8.5 cm / 3½"



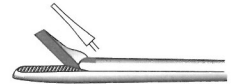
**Hartmann**  
**V-031-1290** 8.5 cm / 3½"  
**V-031-1291** 12 cm / 4¾"  
**V-031-1292** 14 cm / 5½"  
 2 mm  $\varnothing$   
**V-031-1300** 8.5 cm / 3½"  
**V-031-1301** 12 cm / 4¾"  
**V-031-1302** 14 cm / 5½"  
 2.5 mm  $\varnothing$   
**V-031-1310** 8.5 cm / 3½"  
**V-031-1311** 12 cm / 4¾"  
**V-031-1312** 14 cm / 5½"  
 3 mm  $\varnothing$



**Hartmann**  
**V-031-1320**  
 8.5 cm / 3½"



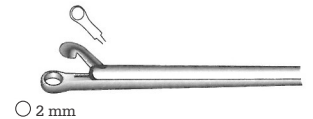
**Struempel**  
**V-031-1330**  
 8.5 cm / 3½"



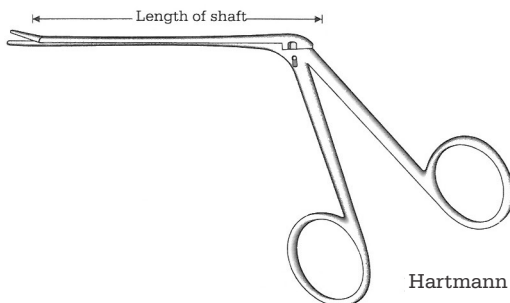
**Hartmann**  
**V-031-1340**  
 8.5 cm / 3½"



**Hartmann**  
**V-031-1350**  
 8.5 cm / 3½"



**Hartmann Hoffmann**  
**V-031-1360**  
 8.5 cm / 3½"





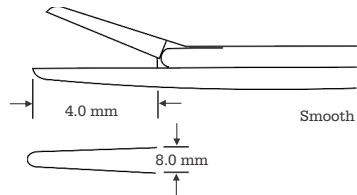
**Hartmann**

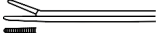

# Otology

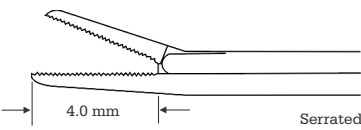
Micro Ear Forceps  
 Mikro-Ohrzangchen  
 Micro pinzas auriculares





-  **V-031-3000**  
80 mm
-  **V-031-3001**  
110 mm  
Smooth, Straight





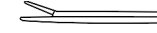

-  **V-031-3050**  
80 mm
-  **V-031-3051**  
110 mm  
Serrated, Straight

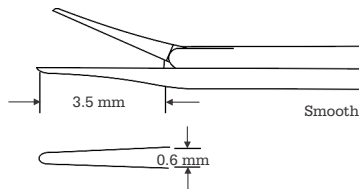




-  **V-031-3055**  
80 mm
-  **V-031-3056**  
110 mm  
Upward, Serrated

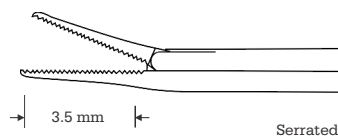




-  **V-031-3060**  
80 mm
-  **V-031-3061**  
110 mm  
Right, Serrated

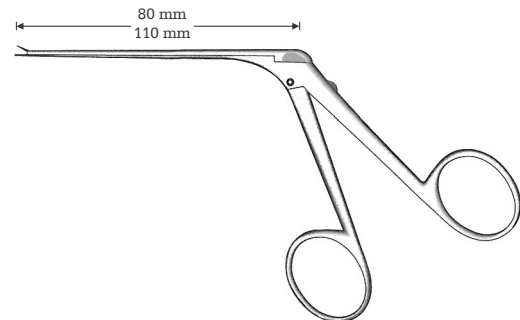
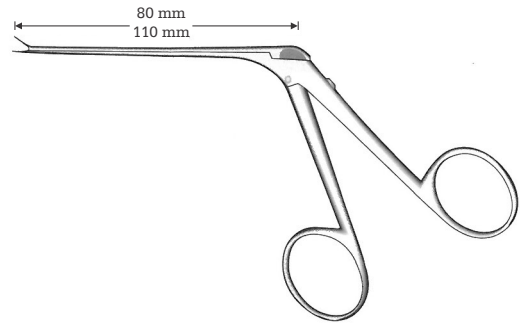
-  **V-031-3065**  
80 mm
-  **V-031-3066**  
110 mm  
Left, Serrated



-  **V-031-3080**  
80 mm
-  **V-031-3081**  
110 mm  
Smooth, straight

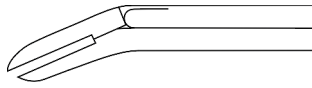


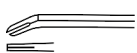
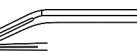
-  **V-031-3090**  
80 mm
-  **V-031-3091**  
110 mm  
Serrated, straight

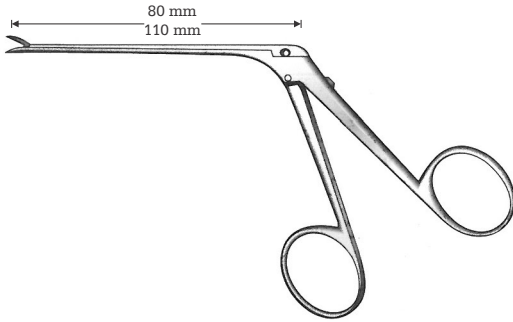


McGee-Mini

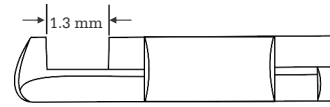


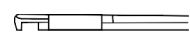
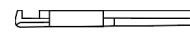


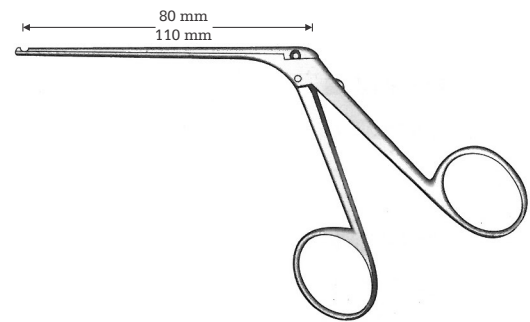
-  **V-031-3100**
- V-031-3105** Black finish  
80 mm
- V-031-3101**
- V-031-3106** Black finish  
110 mm  
0.8 x 3.5 mm
-  **V-031-3110**
- V-031-3115** Black finish  
80 mm
- V-031-3111**
- V-031-3116** Black finish  
110 mm  
0.8 x 6 mm



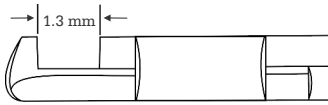
**McGee**  
Wire bending forceps  
bends downward

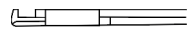
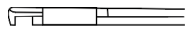


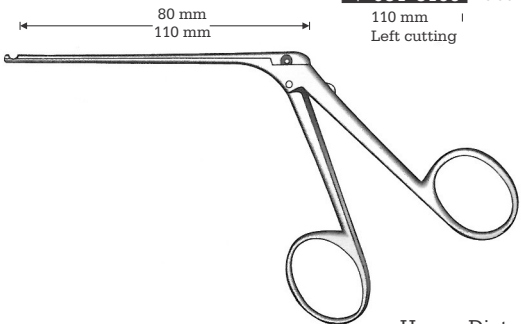
-  **V-031-3120**
- V-031-3125** Black finish  
80 mm
- V-031-3121**
- V-031-3126** Black finish  
110 mm  
Upward cutting
-  **V-031-3130**
- V-031-3135** Black finish  
80 mm
- V-031-3131**
- V-031-3136** Black finish  
110 mm  
Downward cutting



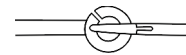
**House-Dieter**  
Malleus nipper



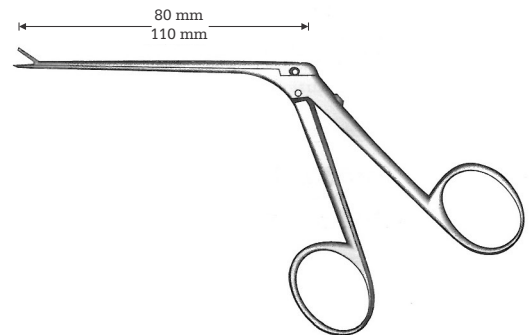
-  **V-031-3150**
- V-031-3155** black finish  
80 mm
- V-031-3151**
- V-031-3156** black finish  
110 mm  
Right cutting
-  **V-031-3160**
- V-031-3165** black finish  
80 mm
- V-031-3161**
- V-031-3166** black finish  
110 mm  
Left cutting



**House-Dieter**  
Malleus nipper



- V-031-3180**
- V-031-3185** Black finish  
80 mm
- V-031-3181**
- V-031-3186** Black finish  
110 mm  
For teflon prosthesis



**Fuller**  
Introducing forceps

# Otology

Micro Cup-Shaped-Forceps and Micro Ear Forceps

Mikro Löffelzangchen und Mikro-Ohrzangchen

Micro-Pinzas con boca en forms de Cucharilla y Micro-pinza auriculares

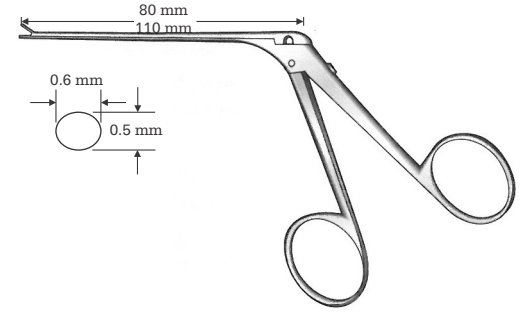
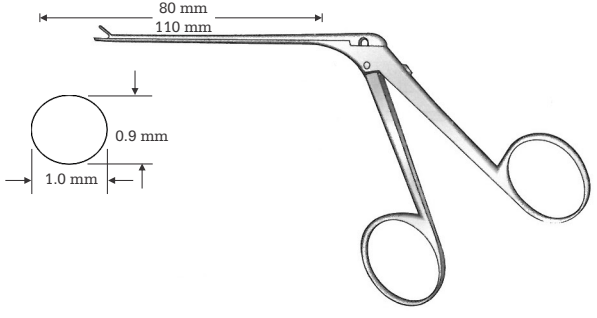


- |  |   |
|--|---|
|  |   |
| <b>V-031-3200</b> 80 mm<br>Straight                | <b>V-031-3210</b> 80 mm<br>Curved up                |
| <b>V-031-3205</b> 80 mm<br>Straight, black finish  | <b>V-031-3215</b> 80 mm<br>Curved up, black finish  |
| <b>V-031-3201</b> 110 mm<br>Straight               | <b>V-031-3211</b> 110 mm<br>Curved up               |
| <b>V-031-3206</b> 110 mm<br>Straight, black finish | <b>V-031-3216</b> 110 mm<br>Curved up, black finish |

- |  |   |
|--|---|
|  |   |
| <b>V-031-3250</b> 80 mm<br>Straight                | <b>V-031-3260</b> 80 mm<br>Curved up                |
| <b>V-031-3255</b> 80 mm<br>Straight, black finish  | <b>V-031-3265</b> 80 mm<br>Curved up, black finish  |
| <b>V-031-3251</b> 110 mm<br>Straight               | <b>V-031-3261</b> 110 mm<br>Curved up               |
| <b>V-031-3256</b> 110 mm<br>Straight, black finish | <b>V-031-3266</b> 110 mm<br>Curved up, black finish |

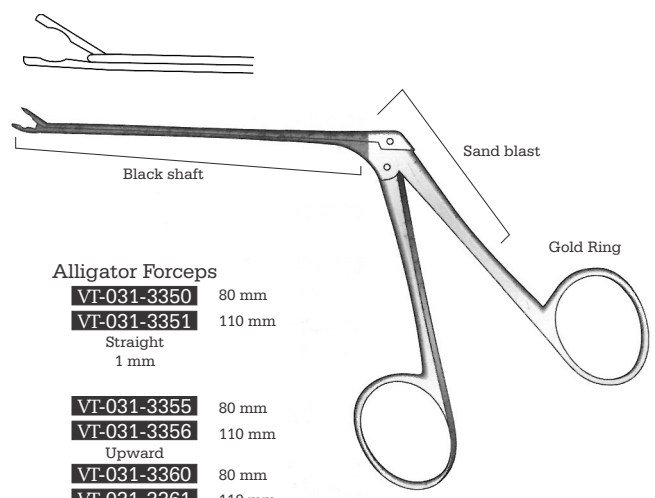
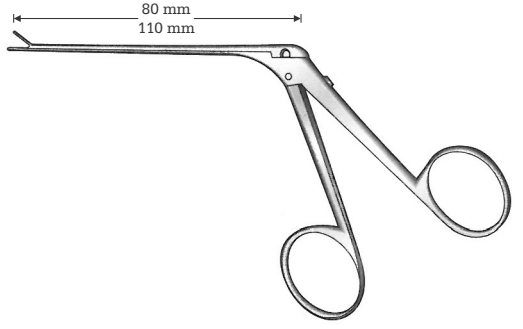
- |   |  |
|---|--|
|   |  |
| <b>V-031-3220</b> 80 mm<br>Right                | <b>V-031-3230</b> 80 mm<br>Left                |
| <b>V-031-3225</b> 80 mm<br>Right, black finish  | <b>V-031-3235</b> 80 mm<br>Left, black finish  |
| <b>V-031-3221</b> 110 mm<br>Right               | <b>V-031-3231</b> 110 mm<br>Left               |
| <b>V-031-3226</b> 110 mm<br>Right, black finish | <b>V-031-3236</b> 110 mm<br>Left, black finish |

- |   |  |
|---|--|
|   |  |
| <b>V-031-3270</b> 80 mm<br>Right                | <b>V-031-3280</b> 80 mm<br>Left                |
| <b>V-031-3275</b> 80 mm<br>Right, black finish  | <b>V-031-3285</b> 80 mm<br>Left, black finish  |
| <b>V-031-3271</b> 110 mm<br>Right               | <b>V-031-3281</b> 110 mm<br>Left               |
| <b>V-031-3276</b> 110 mm<br>Right, black finish | <b>V-031-3286</b> 110 mm<br>Left, black finish |




- |  |   |
|--|---|
|  |   |
| <b>V-031-3300</b> 80 mm<br>Straight                | <b>V-031-3310</b> 80 mm<br>Curved up                |
| <b>V-031-3305</b> 80 mm<br>Straight, black finish  | <b>V-031-3315</b> 80 mm<br>Curved up, black finish  |
| <b>V-031-3301</b> 110 mm<br>Straight               | <b>V-031-3311</b> 110 mm<br>Curved up               |
| <b>V-031-3306</b> 110 mm<br>Straight, black finish | <b>V-031-3316</b> 110 mm<br>Curved up, black finish |


- |   |  |
|---|--|
|   |  |
| <b>V-031-3320</b> 80 mm<br>Right                | <b>V-031-3330</b> 80 mm<br>Left                |
| <b>V-031-3325</b> 80 mm<br>Right, black finish  | <b>V-031-3335</b> 80 mm<br>Left, black finish  |
| <b>V-031-3321</b> 110 mm<br>Right               | <b>V-031-3331</b> 110 mm<br>Left               |
| <b>V-031-3326</b> 110 mm<br>Right, black finish | <b>V-031-3336</b> 110 mm<br>Left, black finish |




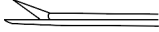
- Alligator Forceps**
- |                          |                           |
|--------------------------|---------------------------|
| <b>VT-031-3350</b> 80 mm | <b>VT-031-3351</b> 110 mm |
| Straight 1 mm            |                           |
| <b>VT-031-3355</b> 80 mm | <b>VT-031-3356</b> 110 mm |
| Upward                   |                           |
| <b>VT-031-3360</b> 80 mm | <b>VT-031-3361</b> 110 mm |
| Downward                 |                           |

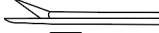
**Alligator Forceps**  
Delicate, Gold Ring  
Tip 1 mm


-  **V-031-3370** Straight
- V-031-3375** Straight, black finish  
80 mm
- V-031-3371** Straight
- V-031-3376** Straight, black finish  
110 mm  
4.0 x 0.6 mm


-  **V-031-3400** Straight
- V-031-3405** Straight, black finish  
80 mm
- V-031-3401** Straight
- V-031-3406** Straight, black finish  
110 mm

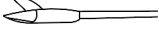
-  **V-031-3410** Curved up
- V-031-3415** Curved up, black finish  
80 mm
- V-031-3411** Curved up
- V-031-3416** Curved up, black finish  
110 mm


-  **V-031-3420** Right
- V-031-3425** Right, black finish  
80 mm
- V-031-3421** Right
- V-031-3426** Right, black finish  
110 mm

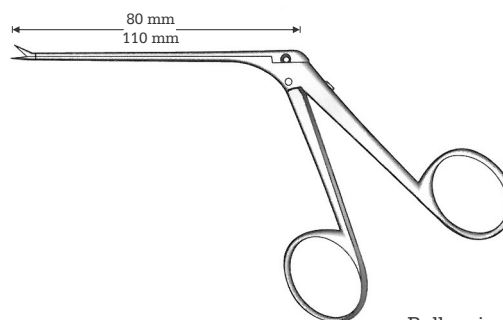
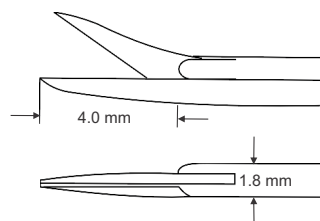
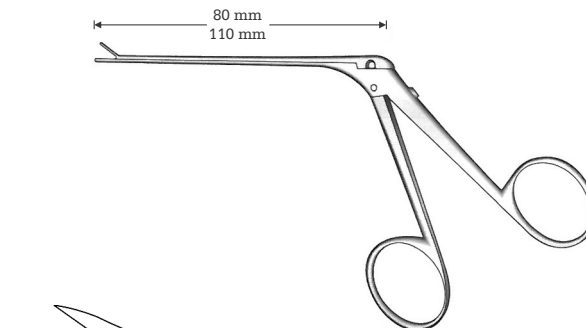
-  **V-031-3430** Left
- V-031-3435** Left, black finish  
80 mm
- V-031-3431** Left
- V-031-3436** Left, black finish  
110 mm

-  **V-031-3450** Straight
- V-031-3455** Straight, black finish  
80 mm
- V-031-3451** Straight
- V-031-3456** Straight, black finish  
110 mm

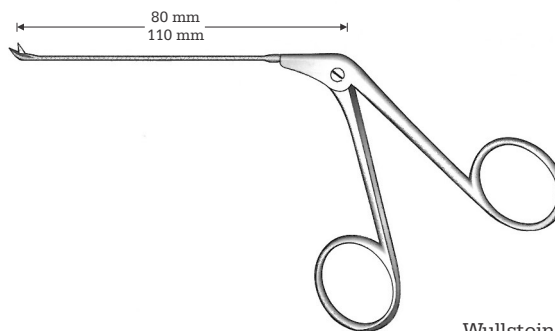
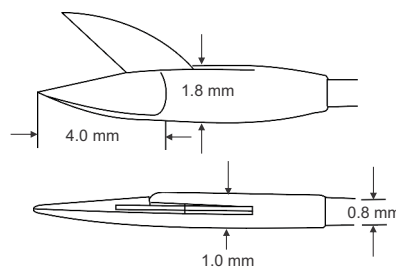
-  **V-031-3460** Curved up
- V-031-3465** Curved up, black finish  
80 mm
- V-031-3461** Curved up
- V-031-3466** Curved up, black finish  
110 mm

-  **V-031-3470** Right
- V-031-3475** Right, black finish  
80 mm
- V-031-3471** Right
- V-031-3476** Right, black finish  
110 mm

-  **V-031-3480** Left
- V-031-3485** Left, black finish  
80 mm
- V-031-3481** Left
- V-031-3486** Left, black finish  
110 mm



**Bellucci**  
Very delicate



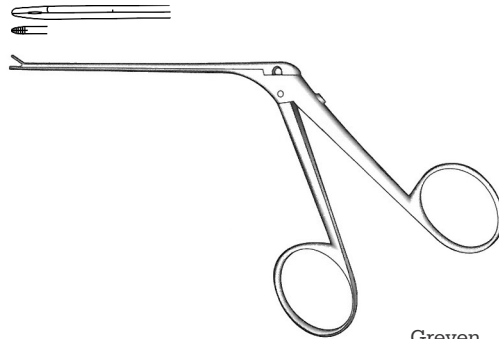
**Wullstein**

# Otology

Wire Closure Forceps, Mastoid Rongeurs

Drahtbiegezungchen, Ohr-Knochenstanzen

Pinzas para doblar alambre, Pinzas cortantes para huesos

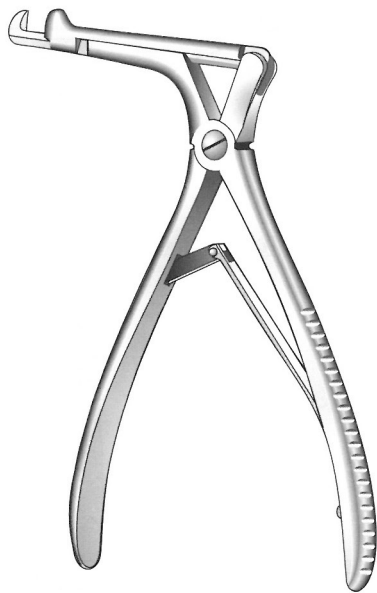


Greven  
V-031-1385

2 mm

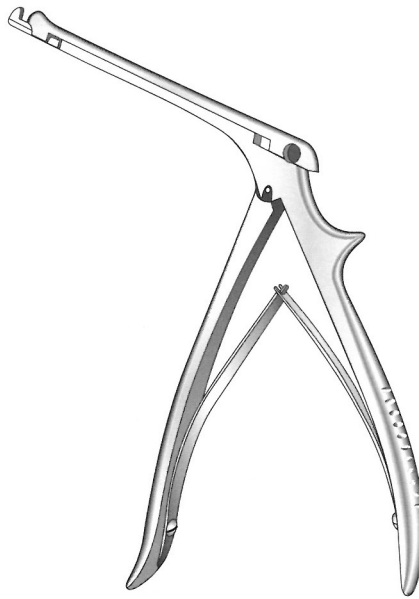


3 mm



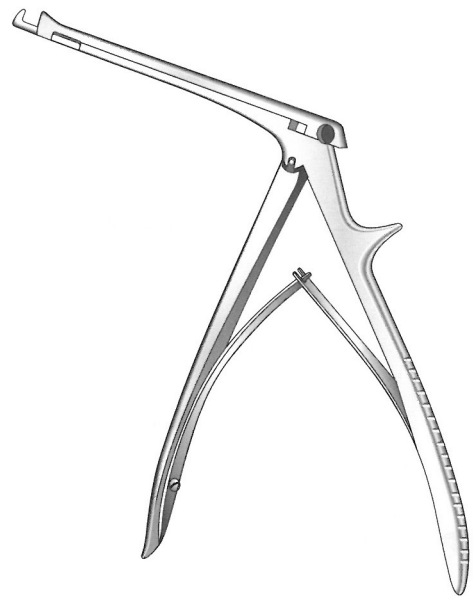
Citelli  
V-031-1386 2 mm  
V-031-1387 3 mm

2 mm

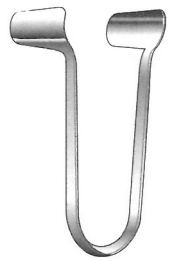


Beyer  
V-031-1388

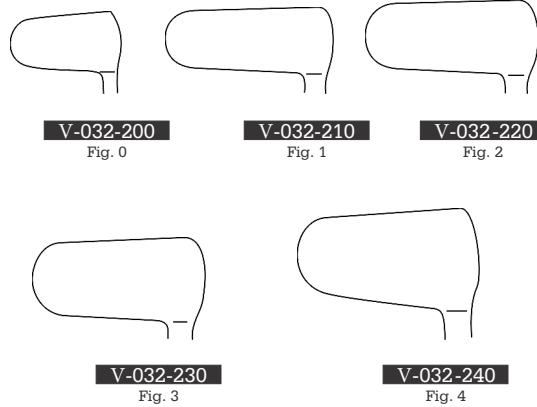
1 mm



Beyer  
V-031-1389



Goldsmith Thudichum



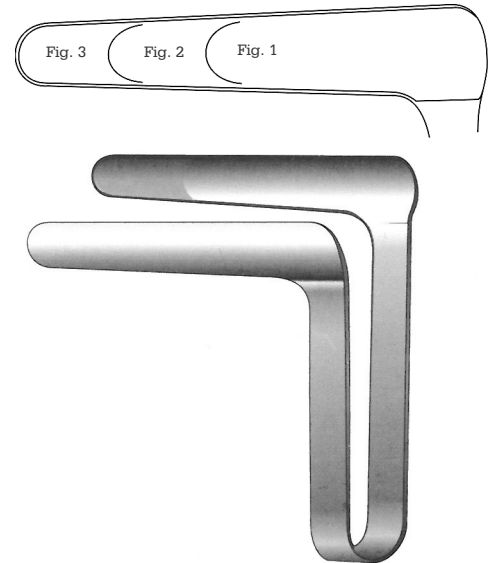
V-032-200  
Fig. 0

V-032-210  
Fig. 1

V-032-220  
Fig. 2

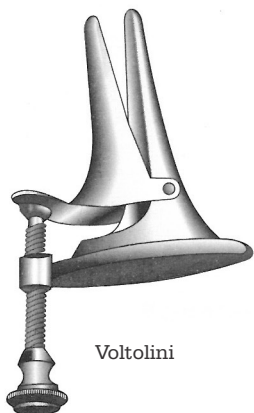
V-032-230  
Fig. 3

V-032-240  
Fig. 4



St. Clair Thomson

- V-032-250 Fig. 1, 35 mm
- V-032-260 Fig. 2, 50 mm
- V-032-270 Fig. 3, 75 mm



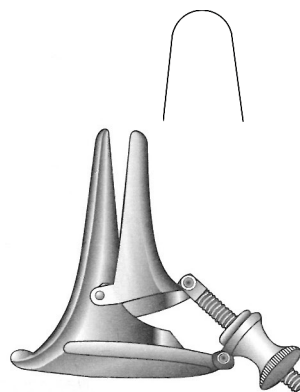
Voltolini



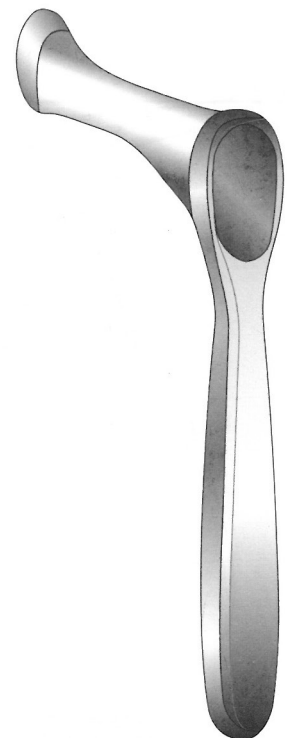
V-032-160  
Fig. 1

V-032-170  
Fig. 2

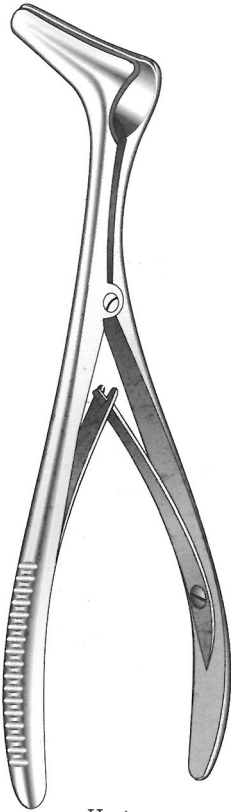
V-032-180  
Fig. 3



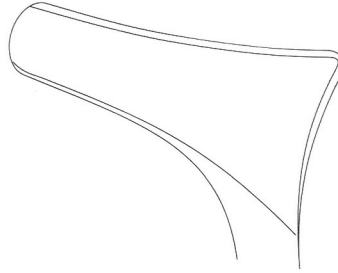
Vacher  
V-032-190



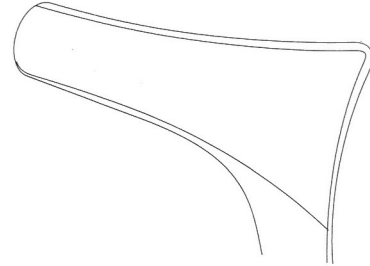
Yankauer  
V-032-280  
19 cm / 7½"



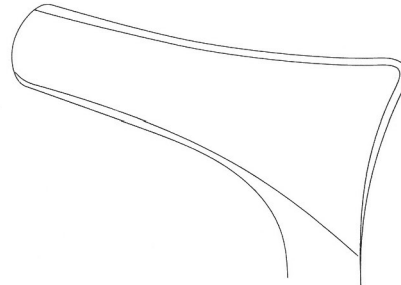
**Hartmann**  
 16.5 cm / 6½"



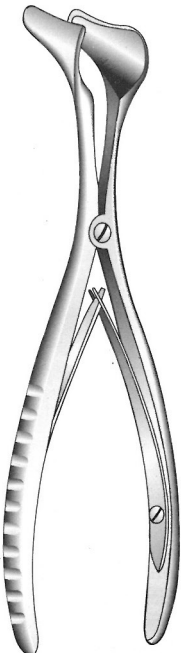
**V-032-001**  
 Fig. 1



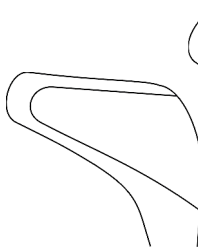
**V-032-010**  
 Fig. 2



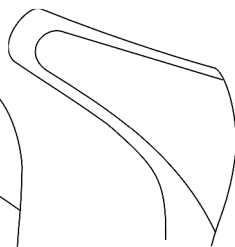
**V-032-020**  
 Fig. 3



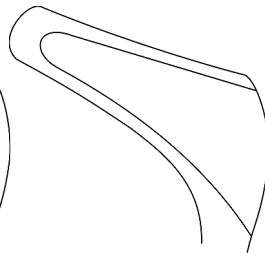
**Hartmann-Halle**  
 15 cm / 6"



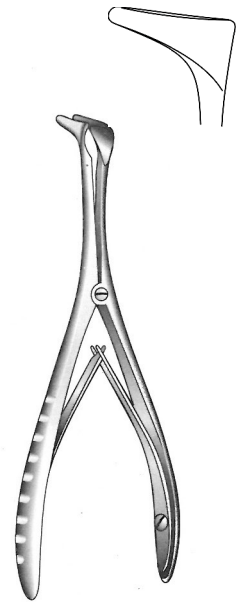
**V-032-030**  
 Fig. 1



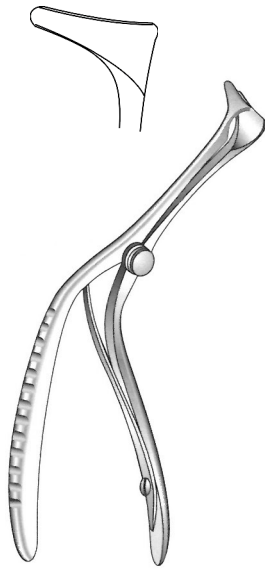
**V-032-040**  
 Fig. 2



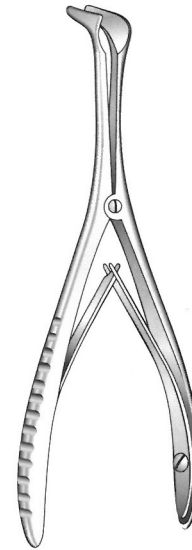
**V-032-050**  
 Fig. 3



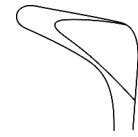
**Mod. Surgicon**  
**V-032-051**  
 13 cm / 5"



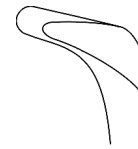
Mod. Surgicon  
**V-032-052**  
 13 cm / 5"



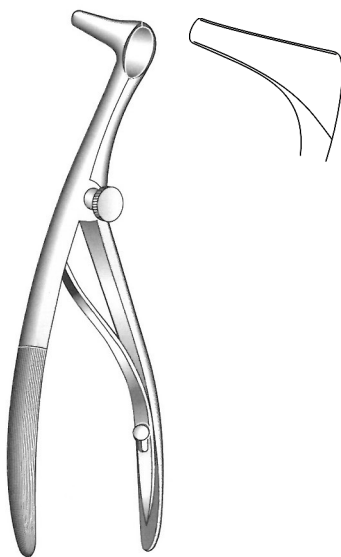
Tieck-Halle  
 13.5 cm / 5 1/4"



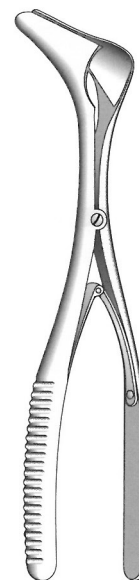
**V-032-140**  
 Fig. 1



**V-032-141**  
 Fig. 2



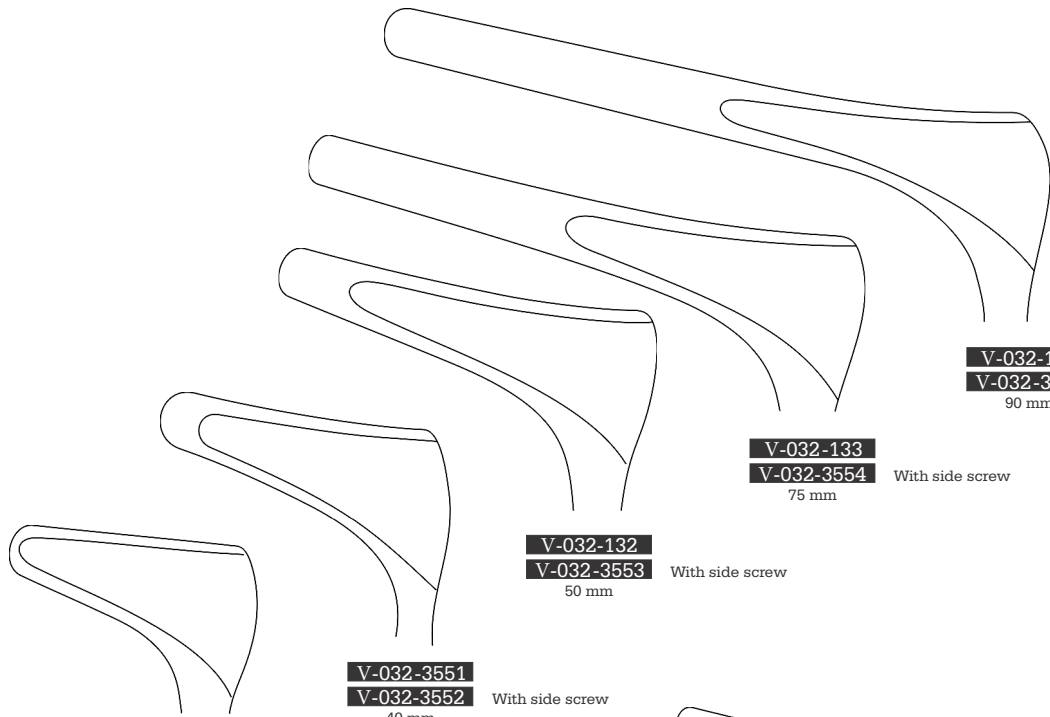
Beckman  
**V-032-053**  
 15 cm / 6"



Vienna  
**V-032-100** Infant  
**V-032-110** Child  
**V-032-120** Adult  
**V-032-125** Sheet  
**V-032-130** Metal  
 14.5 cm / 5 1/2"



**Killian**  
 13 cm / 5"



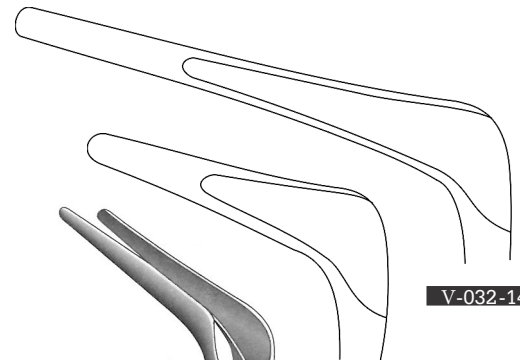
**V-032-134**  
**V-032-3555** With side screw  
 90 mm

**V-032-133**  
**V-032-3554** With side screw  
 75 mm

**V-032-132**  
**V-032-3553** With side screw  
 50 mm

**V-032-3551**  
**V-032-3552** With side screw  
 40 mm

**V-032-131**  
**V-032-3550** With side screw  
 35 mm



**V-032-142**

**V-032-143**



**Cottle**  
 14 cm / 5½"  
 Extra thin blades

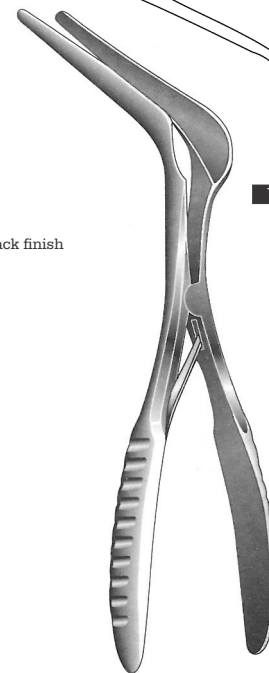
**V-032-138**  
**V-032-3564** Black finish  
 90 mm

**V-032-137**  
**V-032-3563** Black finish  
 75 mm

**V-032-139**  
**V-032-3562** Black finish  
 60 mm

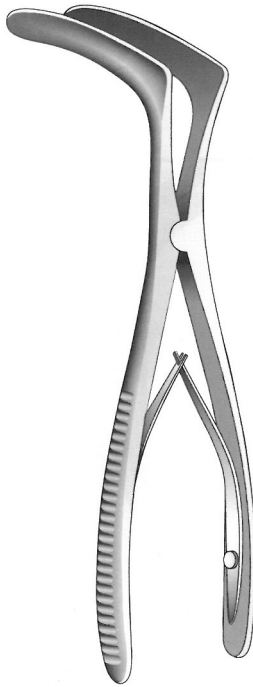
**V-032-136**  
**V-032-3561** Black finish  
 50 mm

**V-032-135**  
**V-032-3560** Black finish  
 35 mm

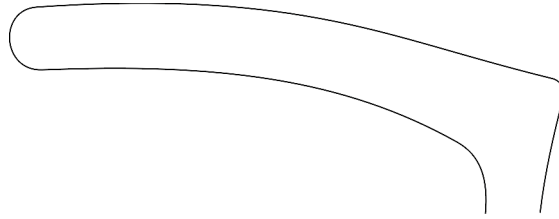


Dull black chrome plated

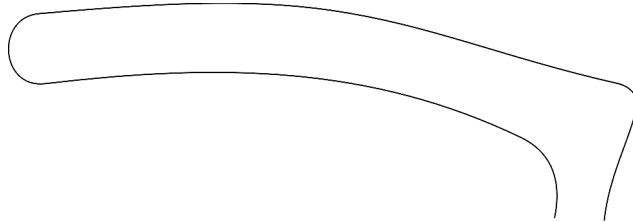




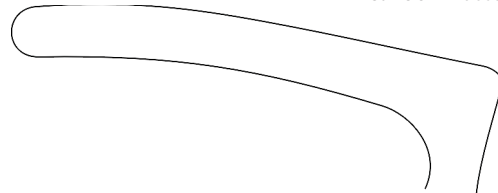
**Tessier**  
17 cm / 6 3/4"  
For dilation, black chromium plated



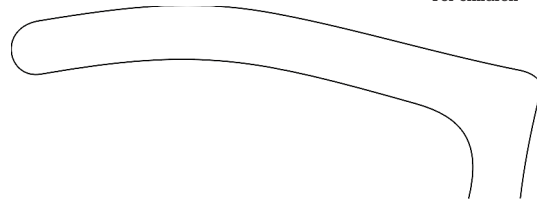
**V-032-144**  
70 x 8.5 mm blade  
For adults



**V-032-145**  
80 x 8.5 mm blade



**V-032-146**  
60 x 7.0 mm blade  
For children



**V-032-147**  
70 x 7.0 mm blade  
For children

# Rhinology

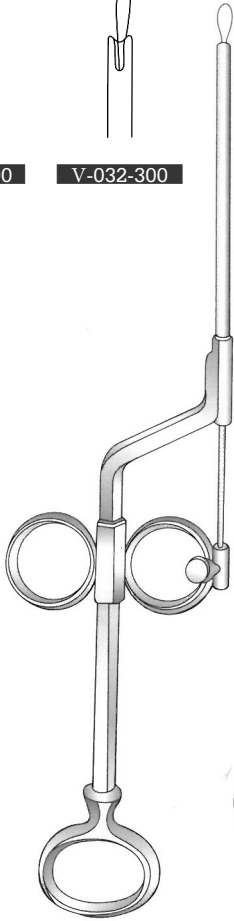
Polypus Snares  
Polypenschnurer  
Polipotomos



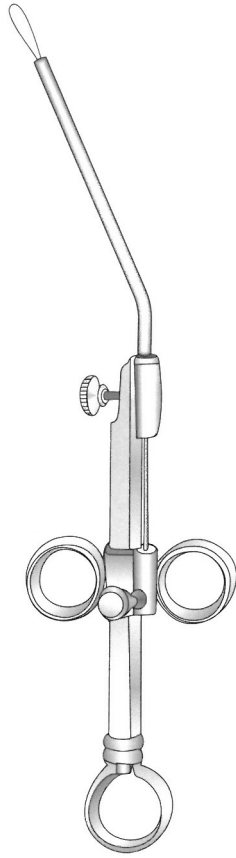
V-032-290



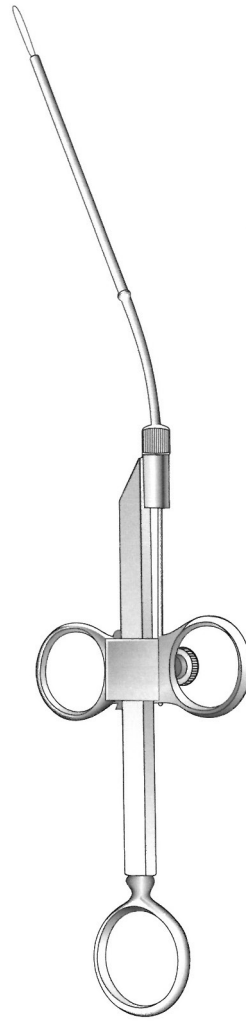
V-032-300



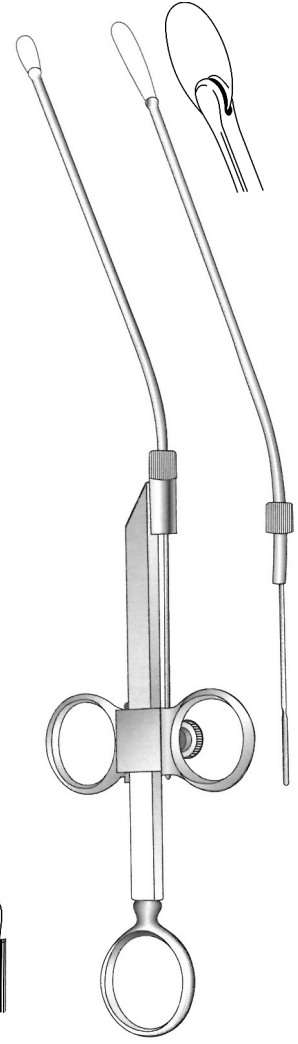
Glegg



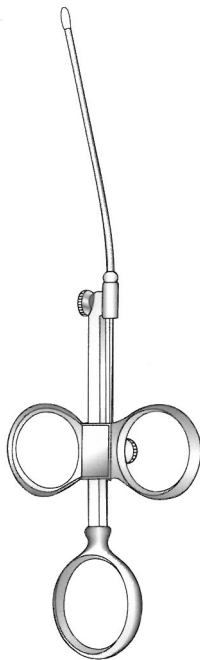
Krause  
V-032-310



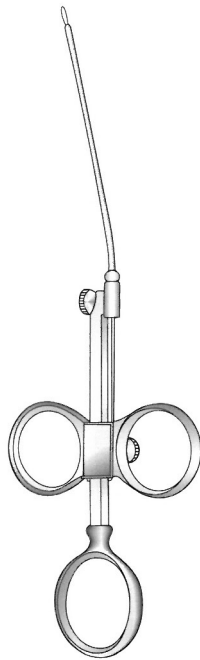
Krause  
V-032-320  
26 cm / 10 1/4"  
3 mm  $\phi$



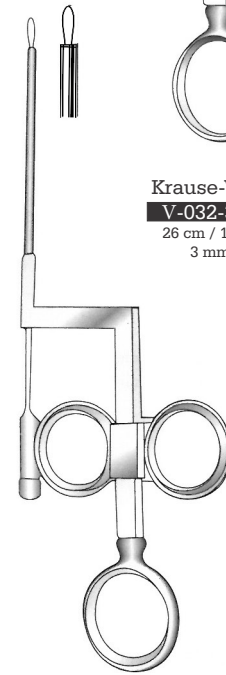
Krause-Voss  
V-032-330  
26 cm / 10 1/4"  
3 mm  $\phi$



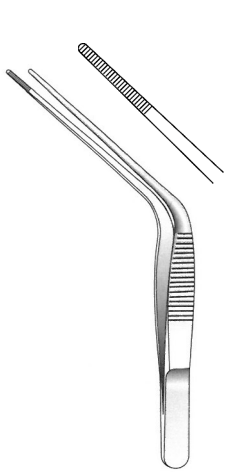
Krause  
V-031-990  
Open tip



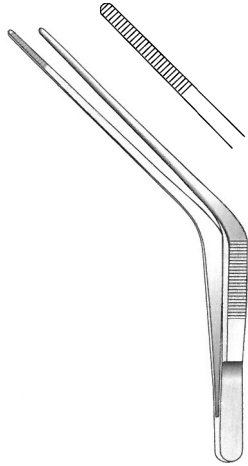
Krause-Voss  
V-031-1000  
Closed tip



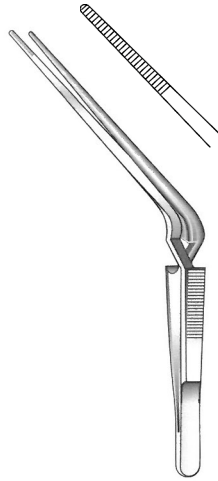
Lange-Wilde  
V-031-1010  
25.5 cm / 10"  
Bayonet shaped



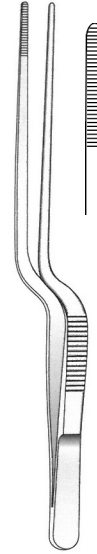
Troeltsch (wilde)  
**V-031-1060**  
11 cm / 4½"



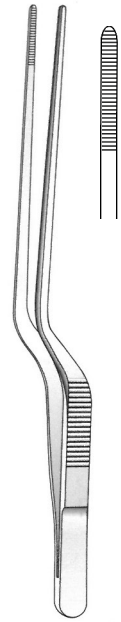
Troeltsch (wilde)  
**V-031-1070**  
12 cm / 4¾"



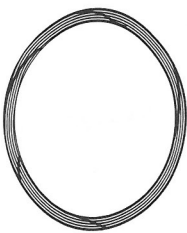
Troeltsch (wilde)  
**V-031-1080**  
13 cm / 5"



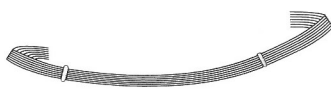
Lucae  
**V-031-1090**  
**V-031-3570** 1:2 Teeth  
14 cm / 5½"



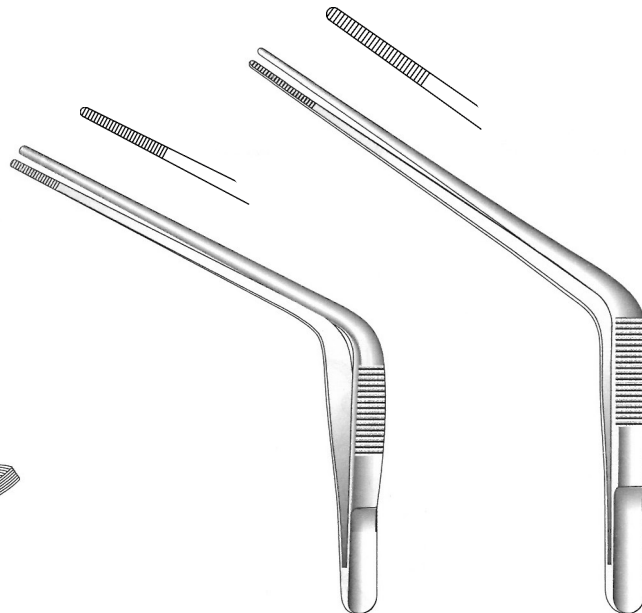
Jansen  
**V-031-1100** 16 cm / 6¼"  
**V-031-1110** 20 cm / 8"



**V-031-1020** 0.3 mm Ø  
**V-031-1030** 0.4 mm Ø  
Snare wire

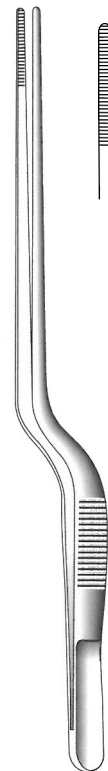


**V-031-1040** 0.2 mm Ø  
**V-031-1050** 0.3 mm Ø  
10.5 cm / 4"  
Snare wire  
12 pieces



Troeltsch  
**V-032-371**  
15 cm / 6"

Troeltsch  
**V-032-372**  
18 cm / 7"



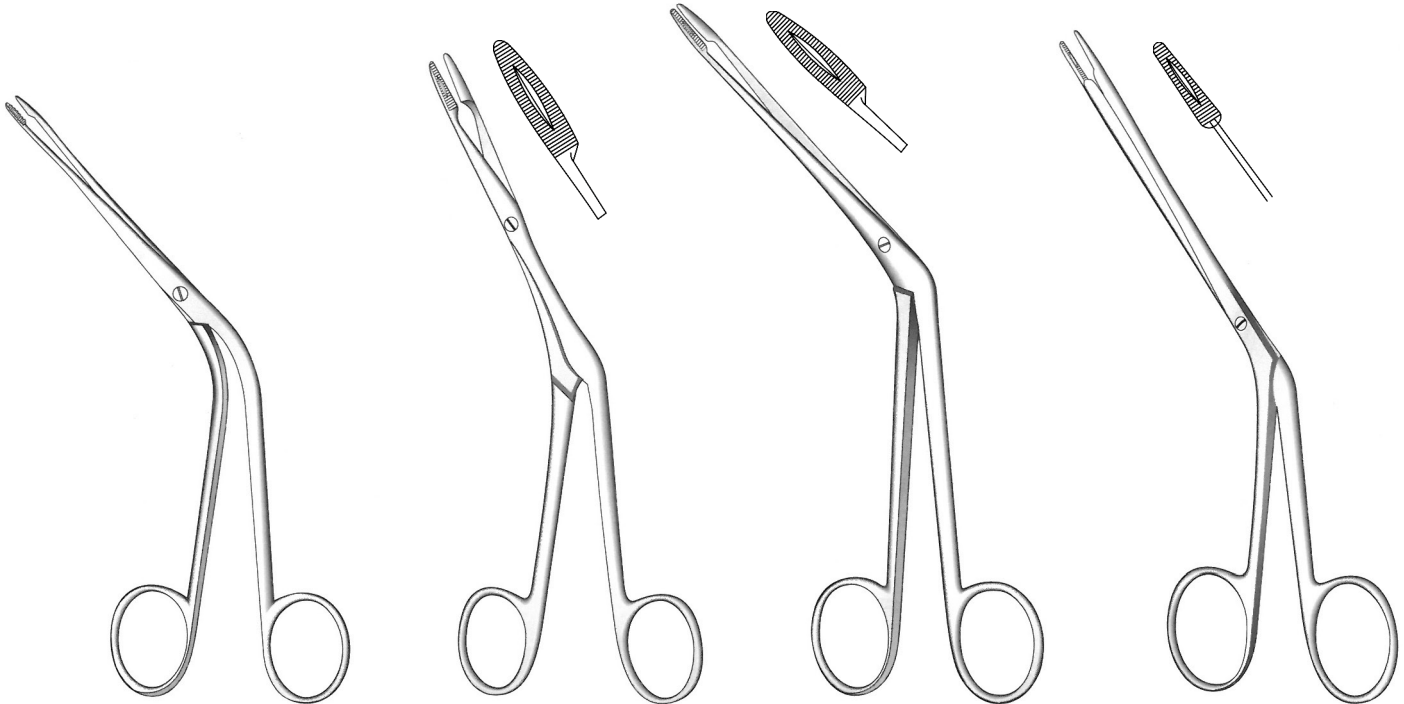
Gruenwald  
(Jansen)  
**V-032-3580** 16 cm / 6¼"  
**V-032-373** 20 cm / 8"

# Rhinology

Nasal Polypus and Septum Compression Forceps

Polypenzangen, Septumzange

Pinzas para Polipos, Pinza para el tabique nasal

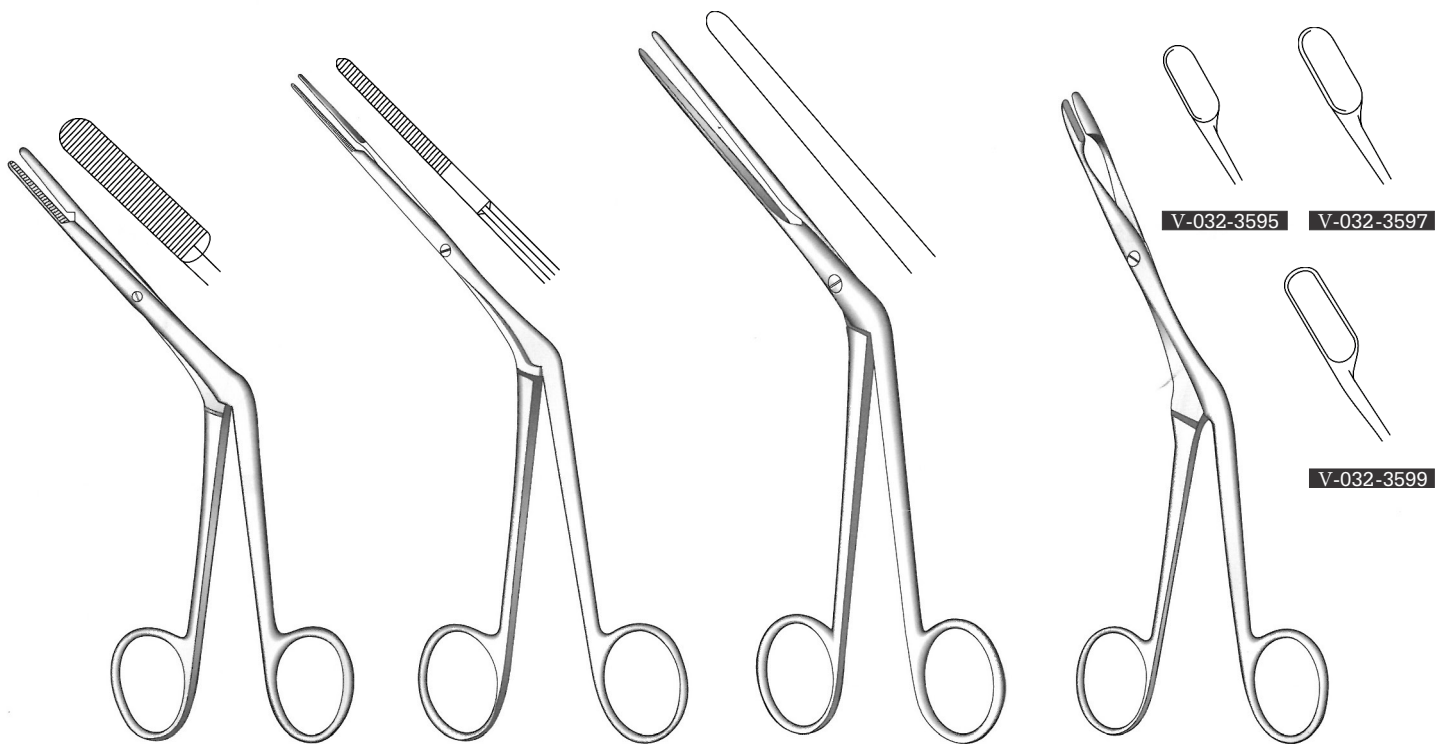


**Hartmann**  
V-032-374  
16 cm / 6¼"

**Heymann-Knight**  
V-032-375  
18 cm / 7"

**Hartmann**  
V-032-376  
20 cm / 8"

**Littauer**  
V-032-377  
18 cm / 7"

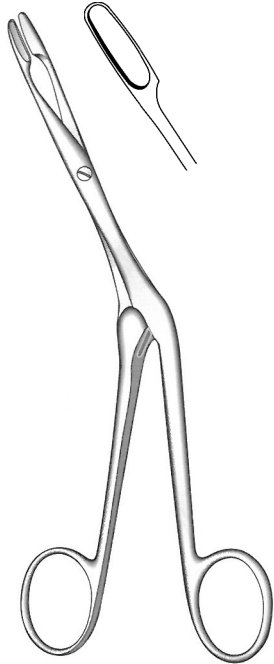


**Killian**  
V-032-378  
17 cm / 6¾"

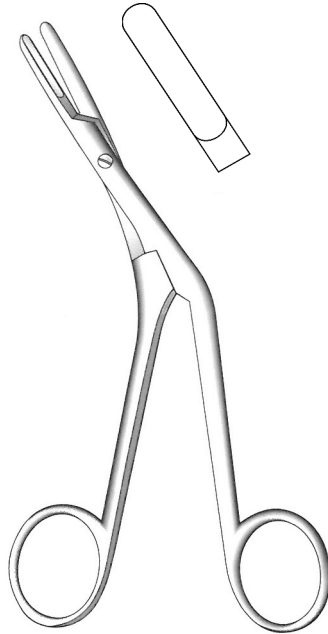
**Westmacott**  
V-032-379  
20 cm / 8"

**Lubet-Barbon**  
V-032-382  
20 cm / 8"  
Nasal tampon forceps

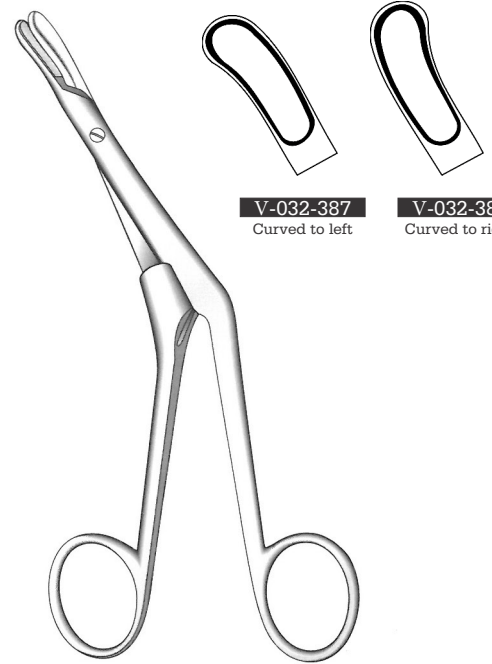
**Heymann**  
18 cm / 7"



**Knight**  
**V-032-383**  
 18 cm / 7"

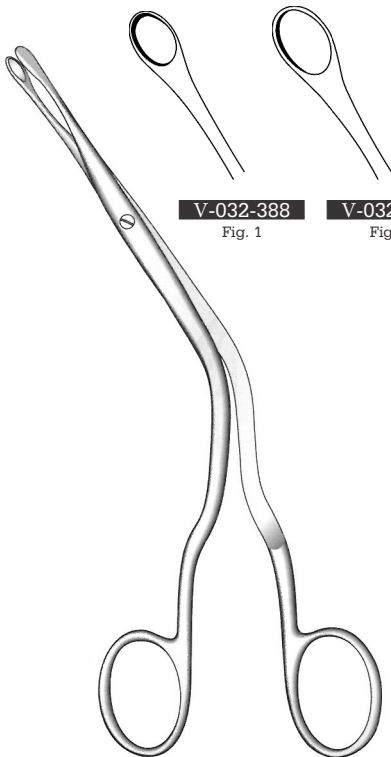


**Graig**  
**V-032-385**  
 18 cm / 7"



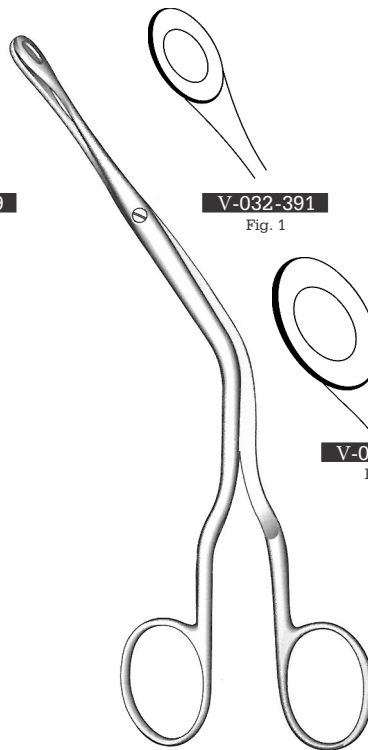
**V-032-387** Curved to left  
**V-032-386** Curved to right

18 cm / 7"



**V-032-388** Fig. 1  
**V-032-389** Fig. 2

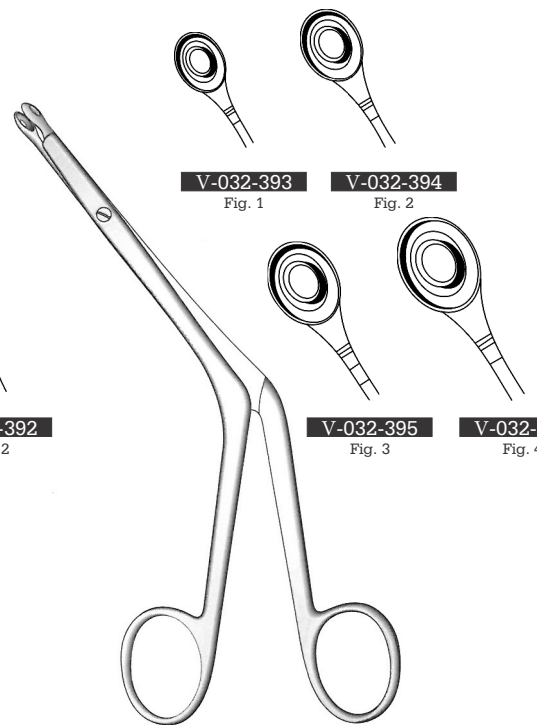
**Luc**  
 20 cm / 8"



**V-032-391** Fig. 1

**V-032-392** Fig. 2

**Luc**  
 20 cm / 8"



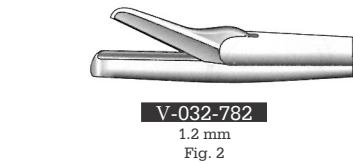
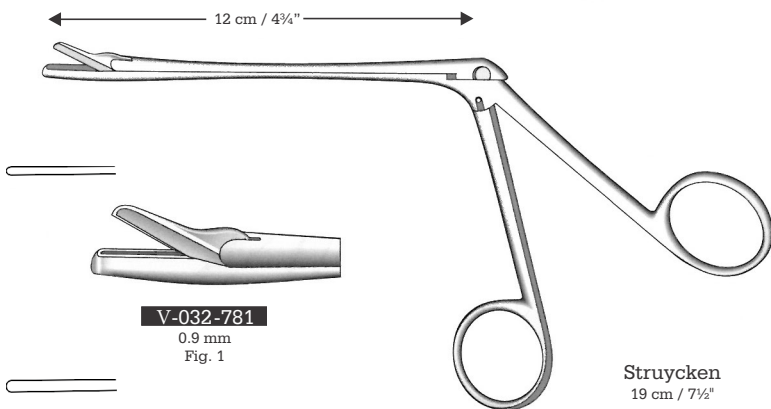
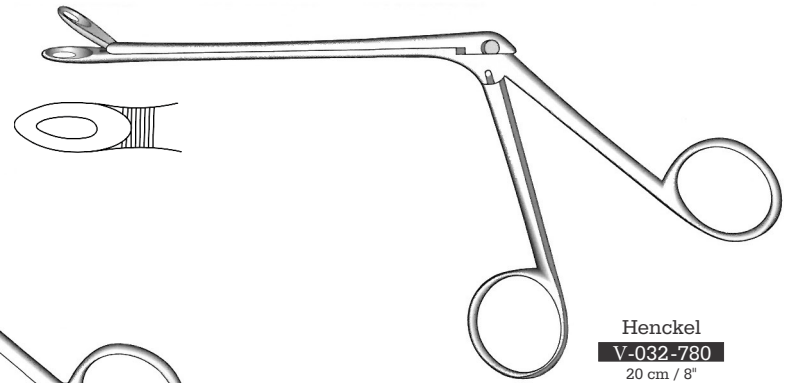
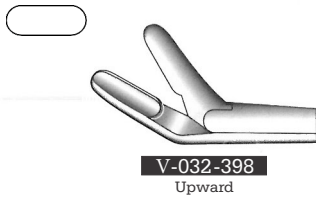
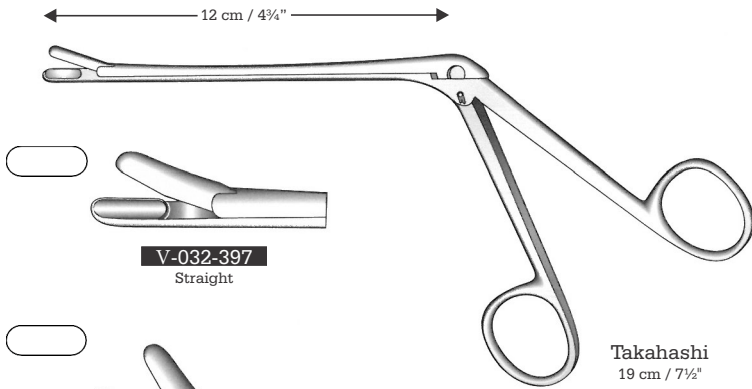
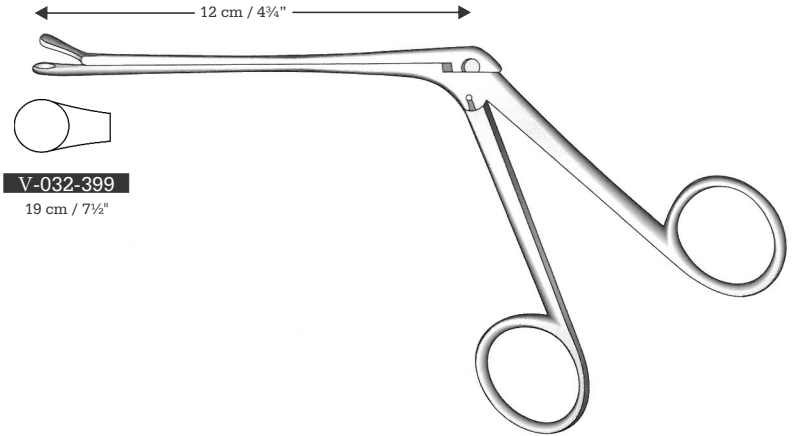
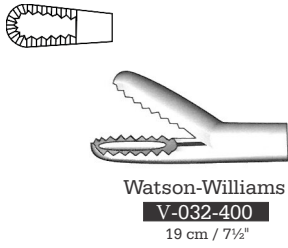
**V-032-393** Fig. 1  
**V-032-394** Fig. 2

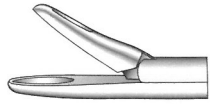
**V-032-395** Fig. 3  
**V-032-396** Fig. 4

**Bruenings**  
 19 cm / 7½"

# Rhinology

Ethmoid Bone Forceps, Nasal Cutting Forceps  
 Siebbeinzangen, Scharfe Nasenzangen  
 Pinzas para etmoides, Pinzas nasal Cortantes





Straight



Fig.1

**V-032-403**  
**V-032-3603**  
 Through cut  
 3.0 mm



Fig.2

**V-032-404**  
**V-032-3604**  
 Through cut  
 3.5 mm



Fig.3

**V-032-405**  
**V-032-3605**  
 Through cut  
 4.5 mm



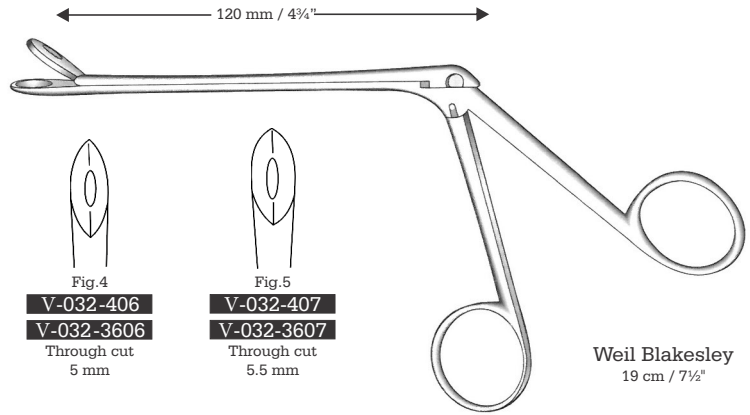
Fig.4

**V-032-406**  
**V-032-3606**  
 Through cut  
 5 mm

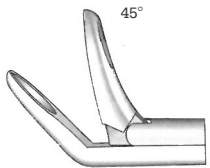


Fig.5

**V-032-407**  
**V-032-3607**  
 Through cut  
 5.5 mm



Weil Blakesley  
 19 cm / 7 1/2"



45°



Fig.1

**V-032-420**  
**V-032-3620**  
 Through cut  
 3.0 mm



Fig.2

**V-032-422**  
**V-032-3622**  
 Through cut  
 3.5 mm



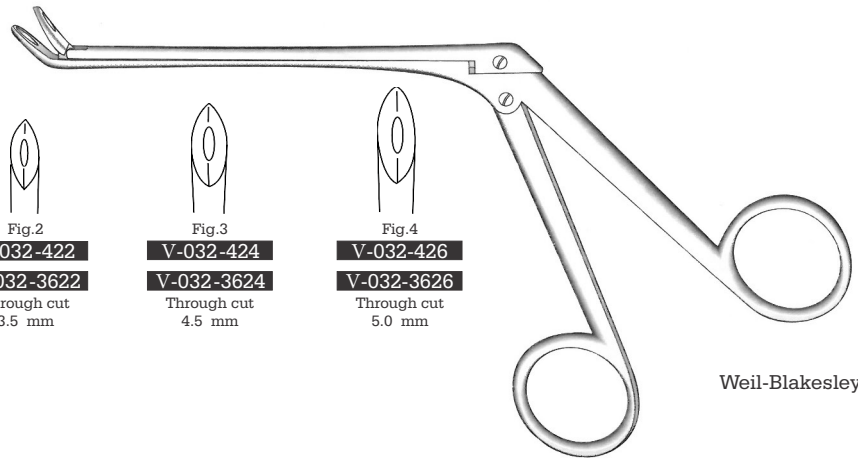
Fig.3

**V-032-424**  
**V-032-3624**  
 Through cut  
 4.5 mm

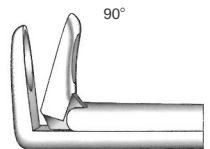


Fig.4

**V-032-426**  
**V-032-3626**  
 Through cut  
 5.0 mm



Weil-Blakesley



90°



Fig.1

**V-032-430**  
 3.0 mm



Fig.2

**V-032-432**  
 3.5 mm



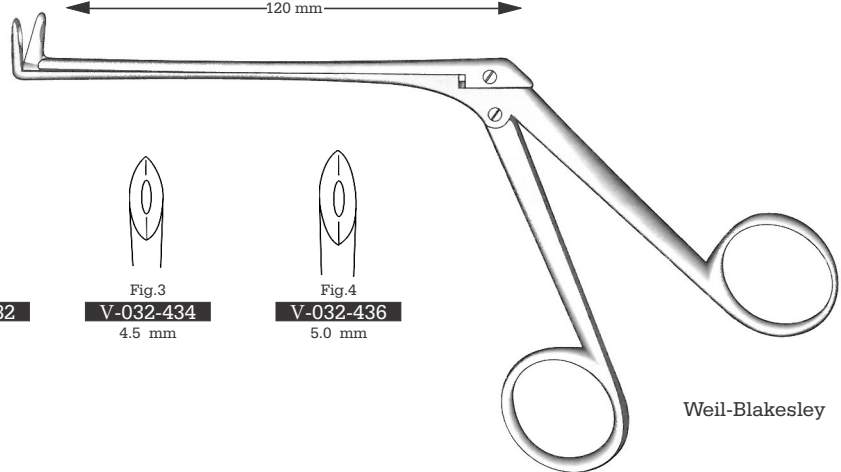
Fig.3

**V-032-434**  
 4.5 mm



Fig.4

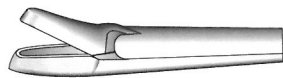
**V-032-436**  
 5.0 mm



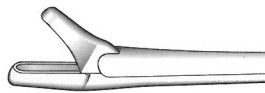
Weil-Blakesley

# Rhinology

Nasal Cutting Forceps  
Scharfe Nasenzangen  
Pinzas nasal cortantes



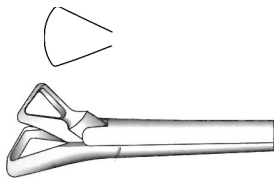
19 cm / 7½"



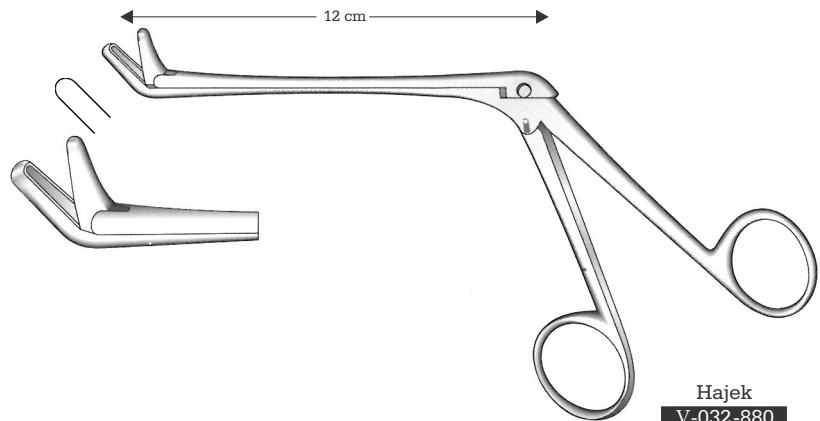
**Myles**  
19 cm / 7½"  
Shaft 12 cm



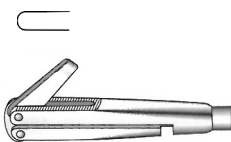
**Hartmann**  
19 cm / 7½"  
Shaft 12 cm



**Schmeden**  
**V-032-879**  
19 cm / 7½"  
Shaft 12 cm



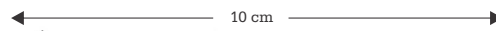
**Hajek**  
**V-032-880**  
19 cm / 7½"



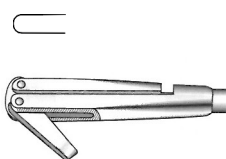
**V-032-925**  
2 mm  
Up cutting



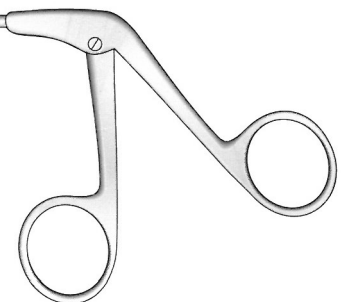
**V-032-926**  
2 mm  
Right cutting



Retrograde cut



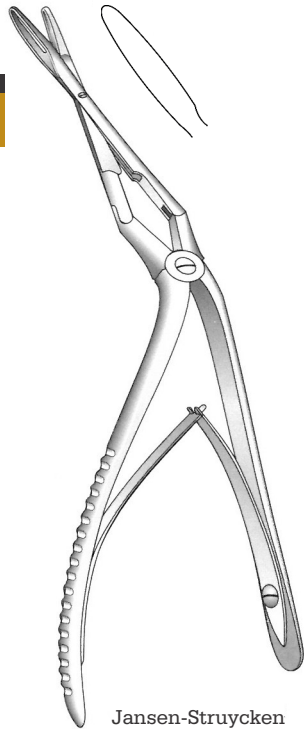
**V-032-927**  
2 mm  
Left cutting



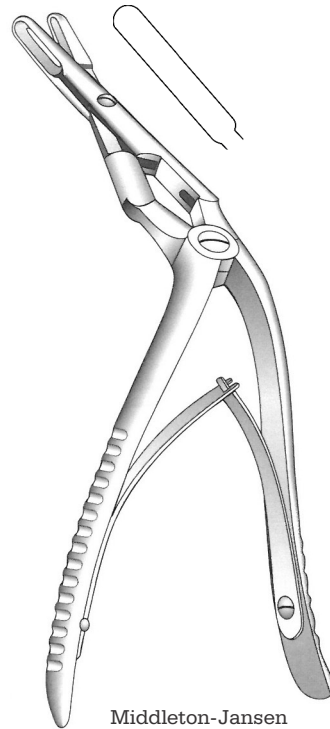
**Stammburger**  
Antrum punch



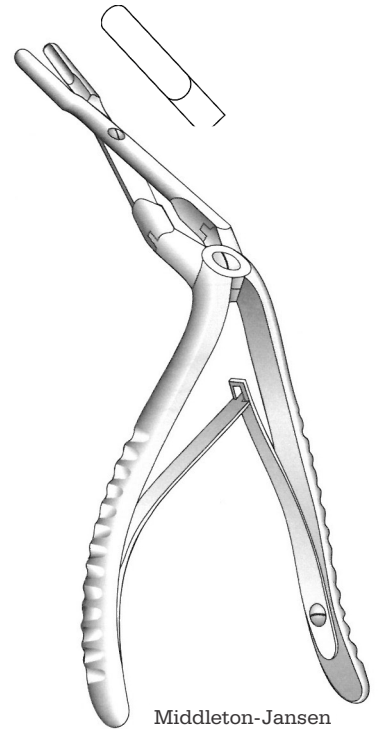
Instruments with Tungsten Carbide Inserts  
**TC GOLD**



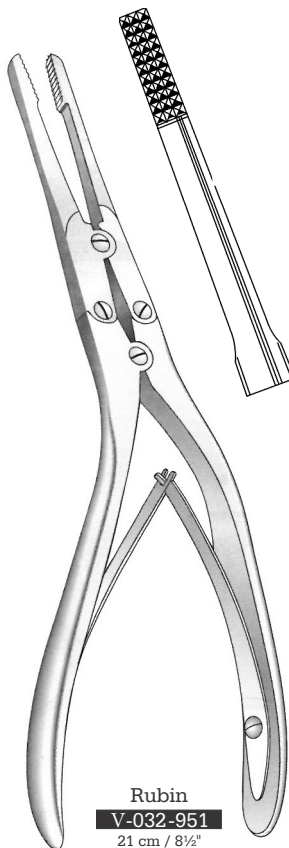
Jansen-Struycken  
**V-032-930**  
 19 cm / 7½"



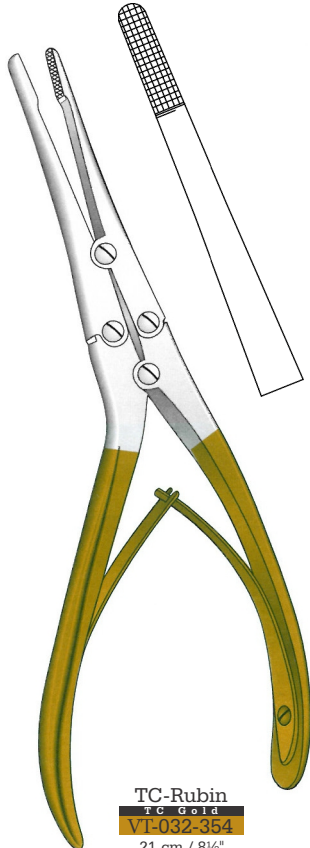
Middleton-Jansen  
**V-032-940**  
 19 cm / 7½"



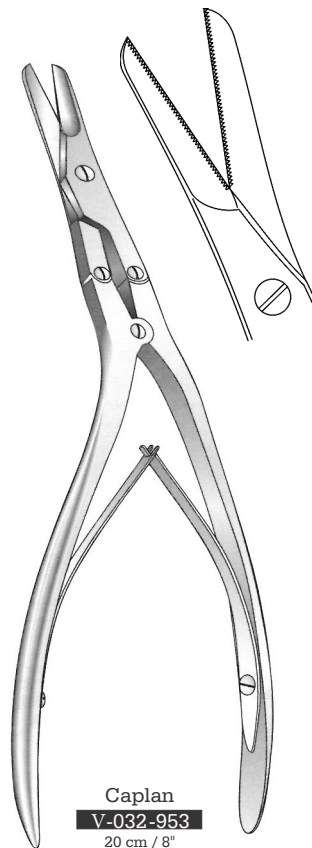
Middleton-Jansen  
**V-032-950**  
 19 cm / 7½"



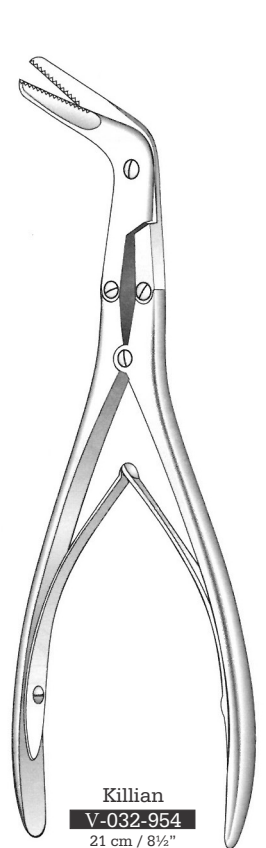
Rubin  
**V-032-951**  
 21 cm / 8½"



TC-Rubin  
**TC GOLD**  
**V-032-354**  
 21 cm / 8½"  
 Surgi Grip



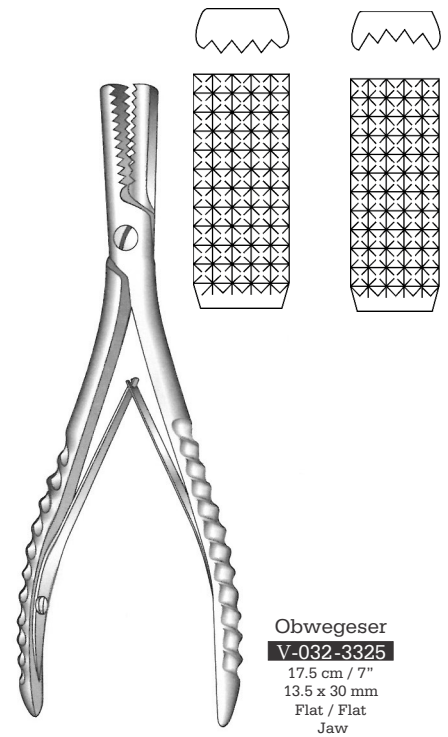
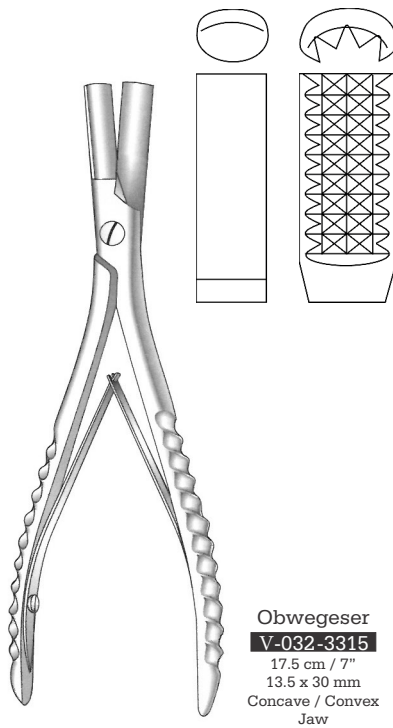
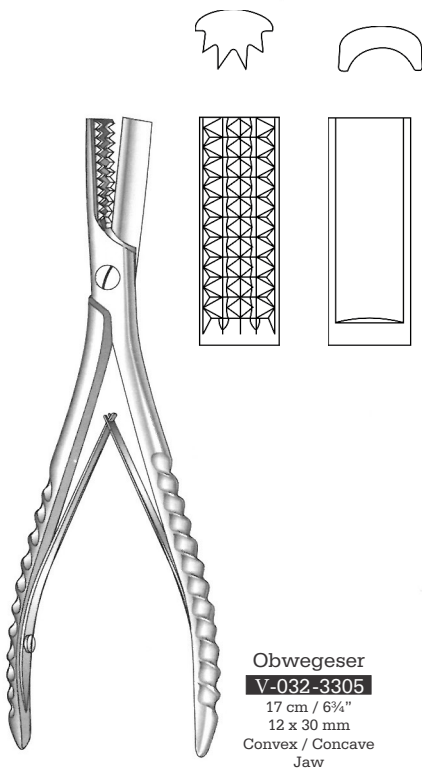
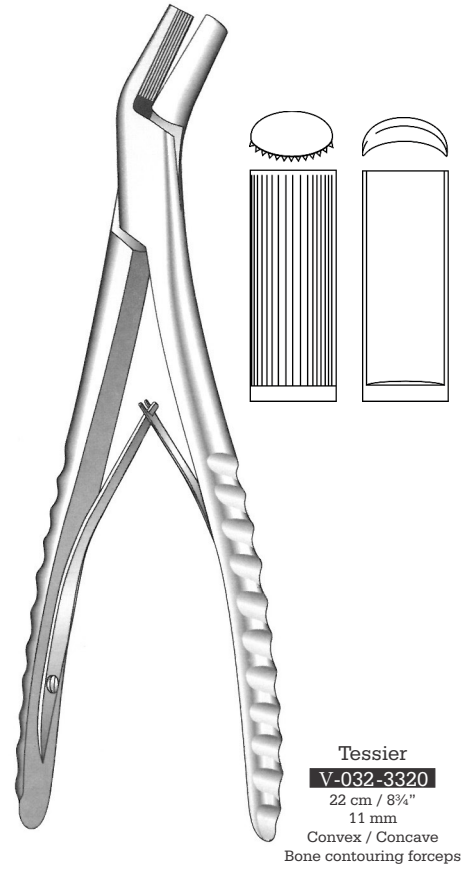
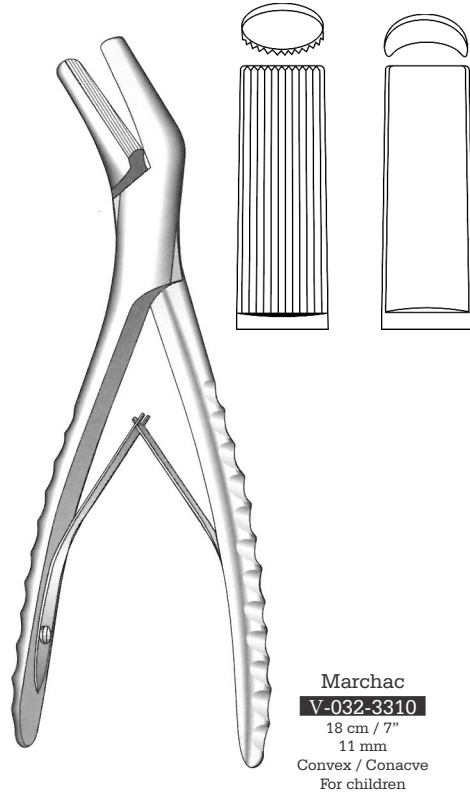
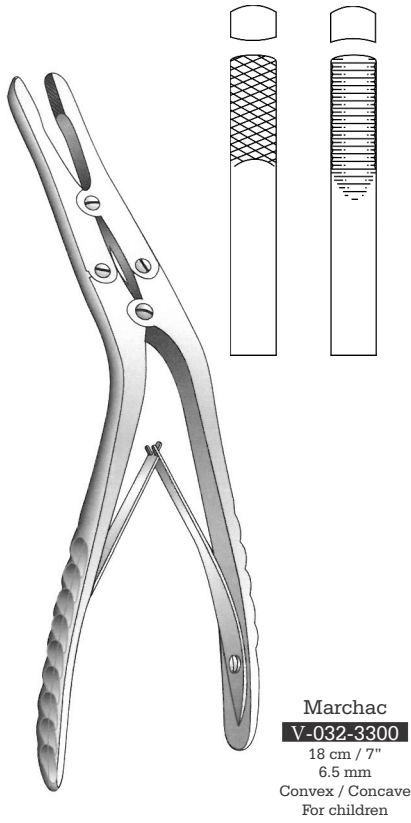
Caplan  
**V-032-953**  
 20 cm / 8"



Killian  
**V-032-954**  
 21 cm / 8½"

# Rhinology

Bone Contouring Forceps  
Knochenformzangen  
Pinzas para formar huesos



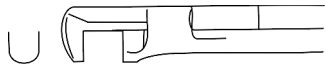


4 x 4 mm

Hajek

**V-032-960**

Upward cutting

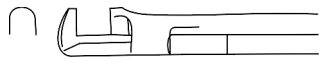


4 x 4 mm

Hajek

**V-032-970**

Downward cutting

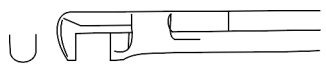


3.5 x 3.5 mm

Hajek-Kofler

**V-032-980**

Upward cutting

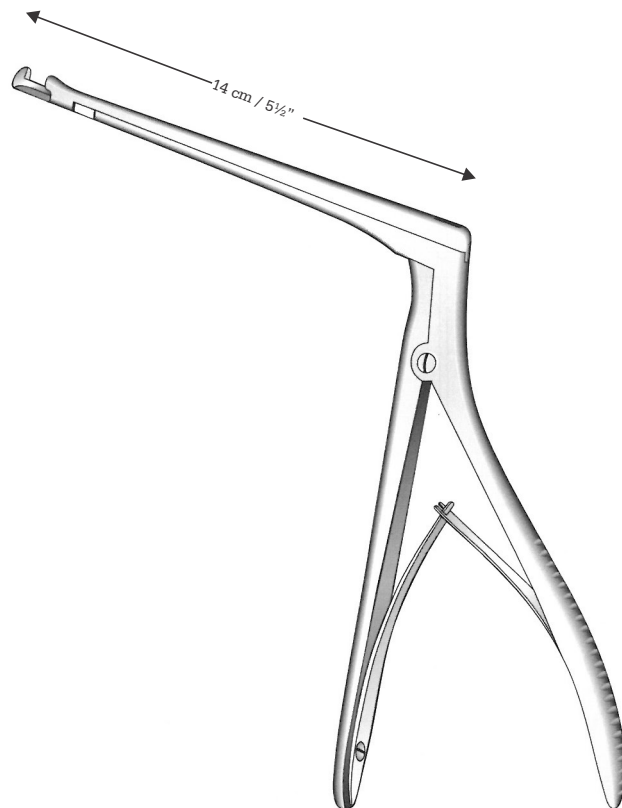


3.5 x 3.5 mm

Hajek-Kofler

**V-032-990**

Downward cutting

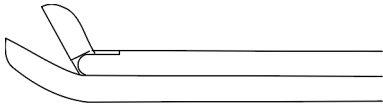







# Rhinology

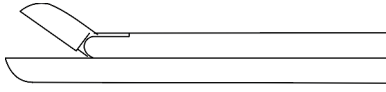
Rongeur Forceps and Antrum Punches Forceps






MeiBelzangen, Kieferhohlenstanzen

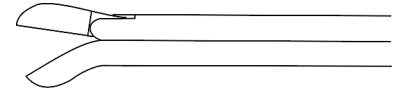
Pinzas gubias, Pinzas Sacabocadas para seno maxilar








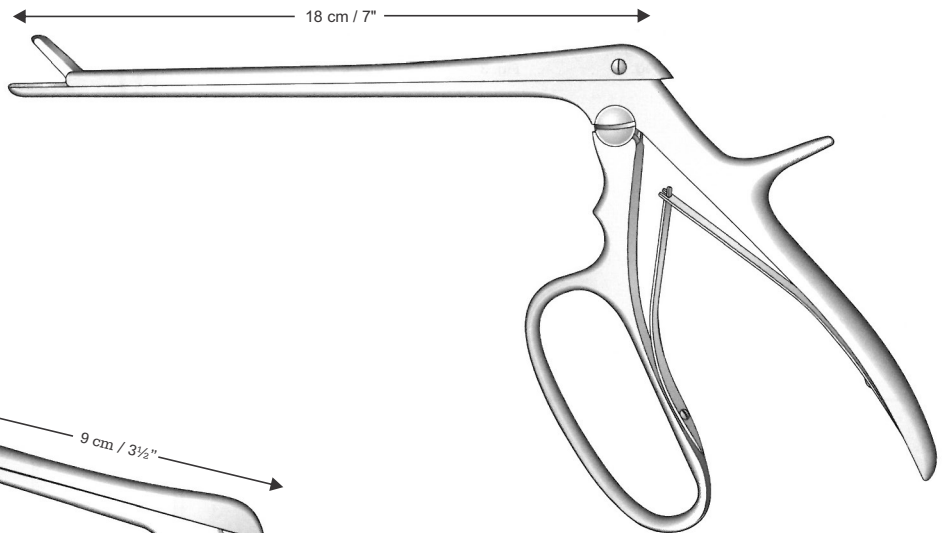
-  **V-032-1081** 2 x 10 mm
-  **V-032-1082** 3 x 10 mm
-  **V-032-1083** 4 x 10 mm
-  **V-032-1084** 5 x 10 mm
-  **V-032-3630** 6 x 10 mm  
Curved up



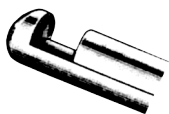
-  **V-032-1085** 2 x 10 mm
-  **V-032-1086** 3 x 10 mm
-  **V-032-1087** 4 x 10 mm
-  **V-032-3635** 5 x 10 mm
-  **V-032-3640** 6 x 10 mm  
Straight






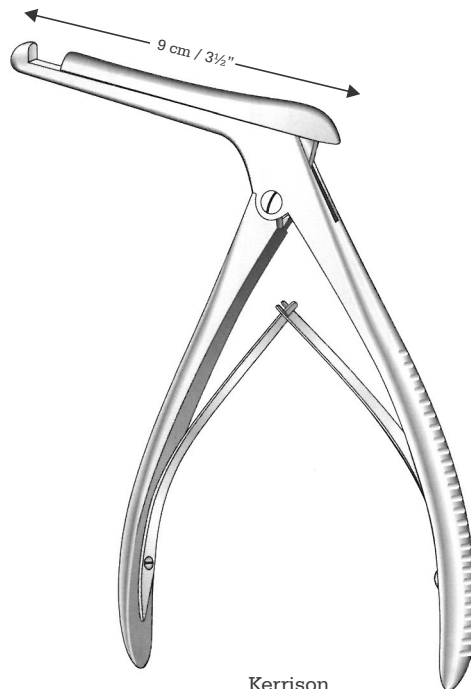
-  **V-032-1088** 2 x 10 mm
-  **V-032-1089** 3 x 10 mm
-  **V-032-1091** 4 x 10 mm
-  **V-032-3650** 5 x 10 mm
-  **V-032-3655** 6 x 10 mm  
Curved down



Ferris-Smith-Cushing



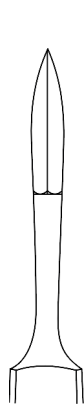
-  **V-032-1060** 4 x 4 mm
-  **V-032-1070** 5 x 5 mm
-  **V-032-1080** 6 x 6 mm



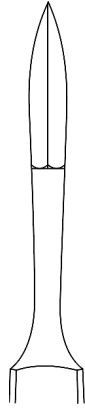
Kerrison  
20 cm / 8"  
Up cutting



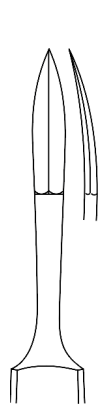
Joseph  
 15 cm / 6"  
 Sharp



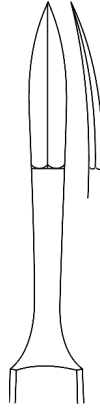
V-032-1090  
 Straight  
 Fig. 1



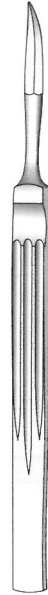
V-032-1100  
 Straight  
 Fig. 2



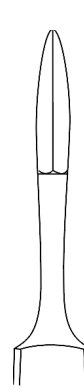
V-032-1110  
 Curved  
 Fig. 3



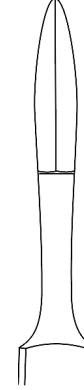
V-032-1120  
 Curved  
 Fig. 4



Joseph  
 15 cm / 6"  
 Blunt



V-032-1130  
 Straight  
 Fig. 1



V-032-1140  
 Straight  
 Fig. 2



V-032-1150  
 Curved  
 Fig. 3



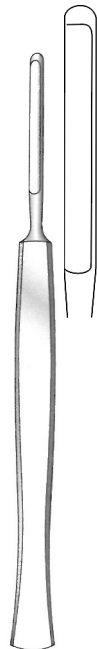
V-032-1160  
 Curved  
 Fig. 4



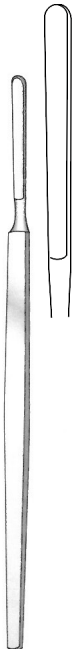
Heymann  
 V-032-1170



Krieg  
 V-032-1180



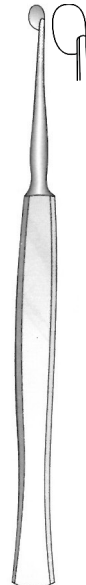
Joseph  
 V-032-1190  
 15 cm / 6"  
 Straight



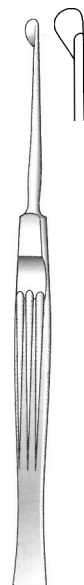
Cottle  
 V-032-1200



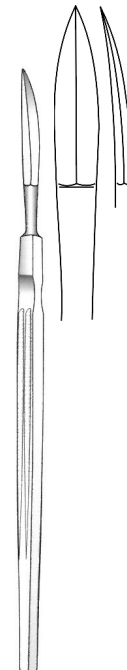
Ballenger  
 V-032-1210



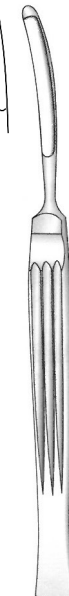
Freer  
 V-032-1220



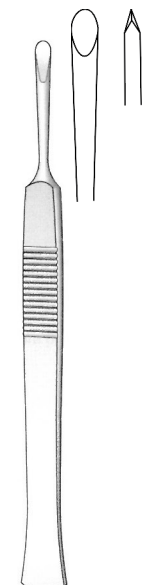
Freer  
 V-032-1230  
 Mucosa knife



Fomon  
 V-032-1231  
 16.5 cm / 6½"



Converse  
 V-032-1232  
 16 cm / 6¼"  
 Curved blade 4 x 35 mm,  
 with button end bistouri



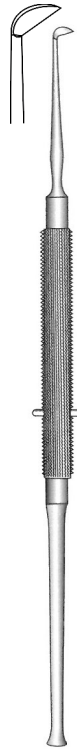
Cottle  
 V-032-1233  
 14 cm / 5½"

# Rhinology

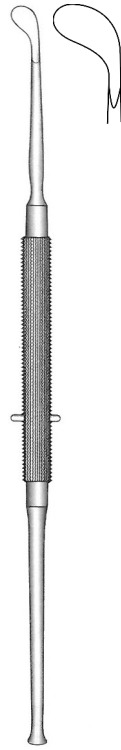
Septum Knives/Septum Elevators and Raspatories  
 Septummesser/Septum-Elevatorian und Raspatorien  
 Bistouries para el tabique nasal Elevador para el tabique nasal Y Legras



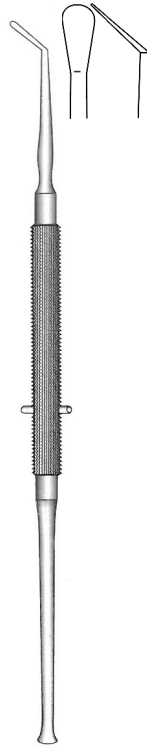
Freer  
**V-032-1240**



Freer  
**V-032-1250**



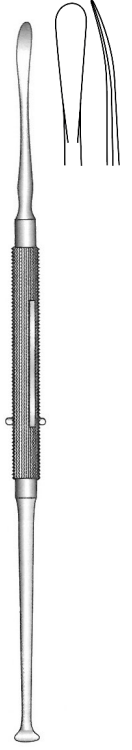
Freer  
**V-032-1260**  
 19 cm / 7½"



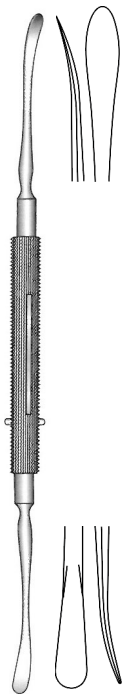
Freer  
**V-032-1270**  
 19 cm / 7½"



Freer  
**V-032-1280**  
 19 cm / 7½"  
 Sharp  
 5 mm



Freer  
**V-032-1290**  
 19 cm / 7½"  
 Blunt  
 6 mm



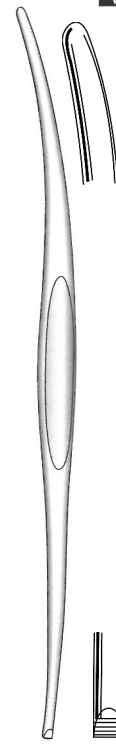
Freer  
**V-032-1300** 16 cm / 6¼"  
**V-032-1305** 19 cm / 7½"  
 Sharp / Blunt  
 5 / 5 mm



Durham  
**V-032-1310**



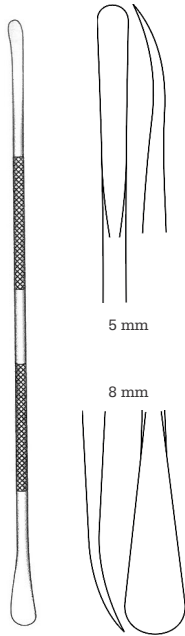
Howarth  
**V-032-1320**



Hill  
**V-032-1330**



Freer  
**V-032-3350** 19.5 cm / 7¾"  
**V-032-3351** 22 cm / 8¾"  
 Blunt / Sharp  
 Square handle

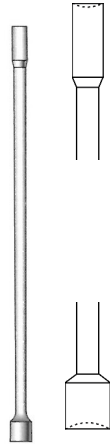


Terry

**V-032-2100**

17 cm / 6 3/4"

For elevation of alveolar flaps

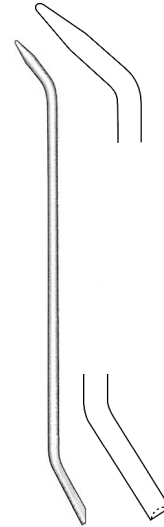


Terry

**V-032-2110**

11 cm / 4 1/4"

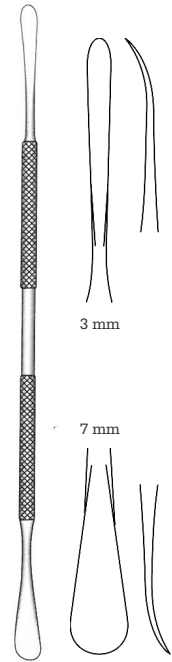
Graft packer



**V-032-2120**

13 cm / 5"

Graft packer

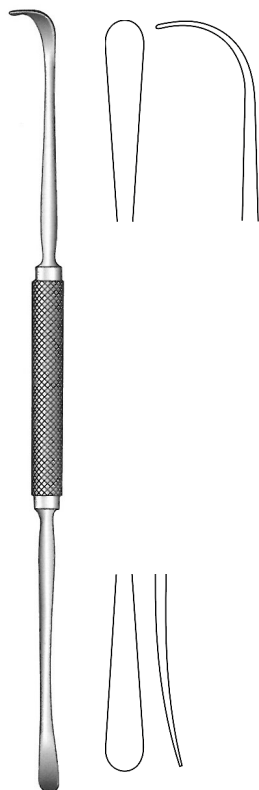


Terry

**V-032-2130**

18 cm / 7"

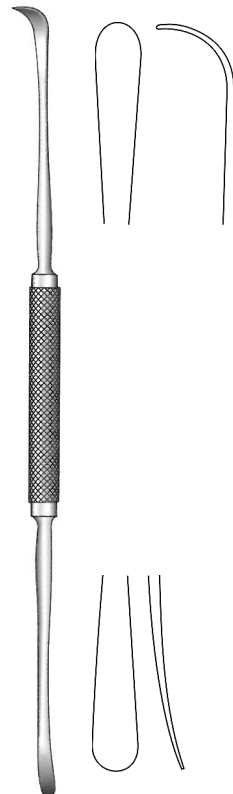
For subperiosteal tunnels



Obwegeser

**V-032-2230**

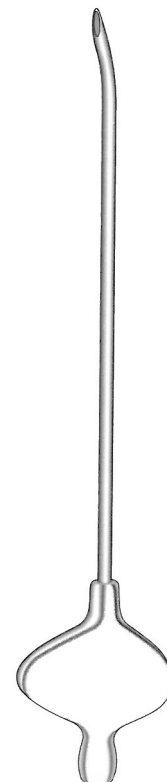
20.5 cm / 8"



Obwegeser

**V-032-2240**

20.5 cm / 8"



**V-032-3360**

2 mm

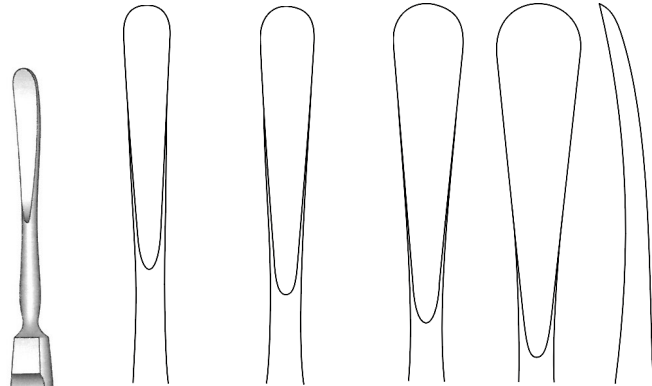
Sharp point

# Rhinology

Periosteal Elevators

Raspatorien

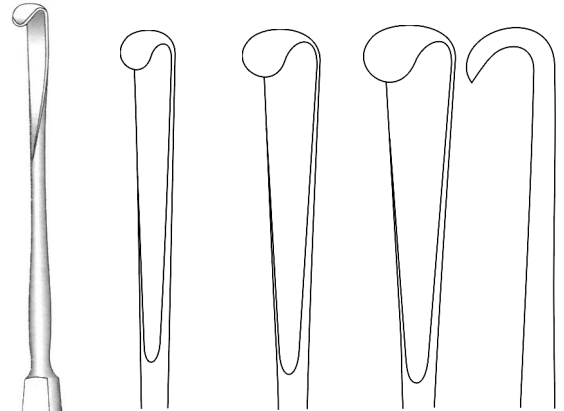
Legras



**V-032-2320** 6 mm  
**V-032-2321** 7 mm  
**V-032-2322** 9 mm  
**V-032-2323** 11 mm



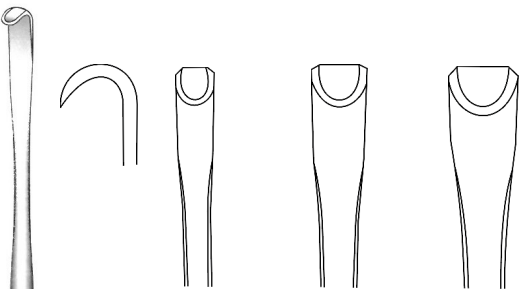
Obwegeser  
17.5 cm / 7"



**V-032-2330** 5 mm  
**V-032-2331** 7 mm  
**V-032-2332** 9 mm



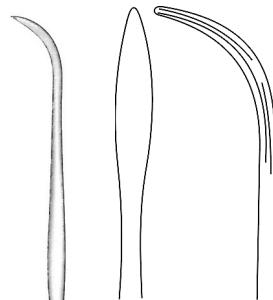
Obwegeser  
20.5 cm / 8"



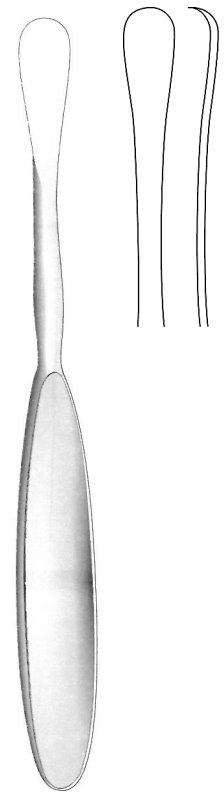
**V-032-3365** 5 mm  
**V-032-3370** 7 mm  
**V-032-3375** 9 mm



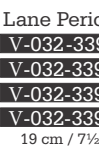
Obwegeser  
20.5 cm / 8"



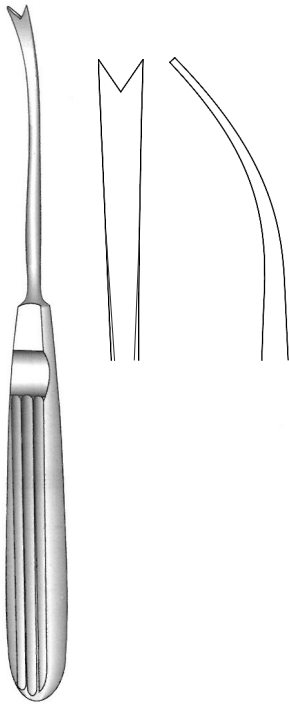
Steinhauser  
**V-032-2340**  
18.5 cm / 7 1/4"



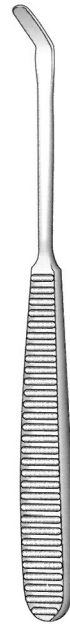
Lane Periosteal Elevator  
**V-032-3390** Narrow tip sharp  
**V-032-3391** Wide tip sharp  
**V-032-3392** Narrow tip blunt  
**V-032-3393** Wide tip blunt  
 19 cm / 7 1/2"







Steinhäuser  
**V-032-2280**  
 18 cm / 7"  
 Reposition instrument

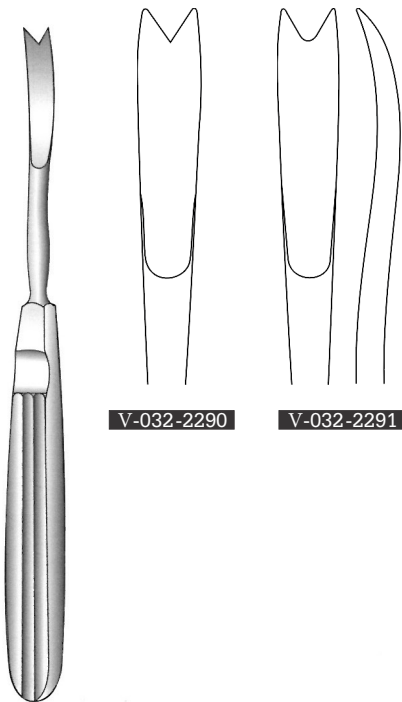


Steinhäuser

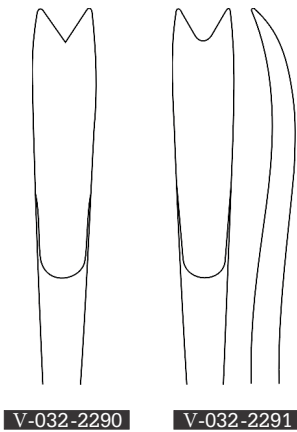
**V-032-2270**  
 16 cm / 6¼"  
 6 x 12 mm

**V-032-2271**  
 16.5 cm / 6½"  
 6 x 19 mm

**V-032-2272**  
 17 cm / 6¾"  
 6 x 26 mm

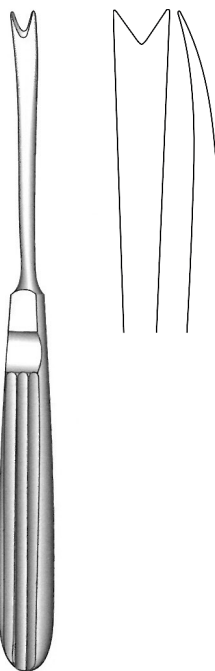


Obwegeser  
 17.5 cm / 7"

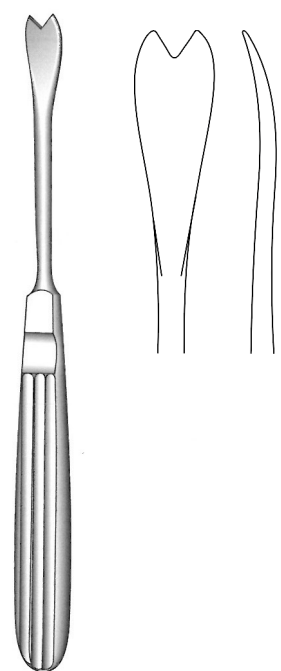


**V-032-2290**

**V-032-2291**



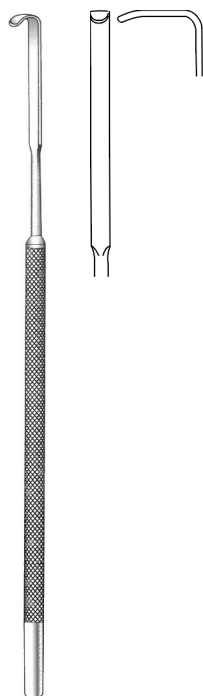
Obwegeser  
**V-032-2300**  
 17.5 cm / 7"  
 7.5 mm



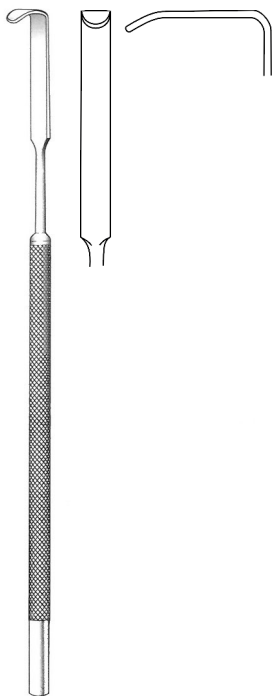
Obwegeser  
**V-032-2310**  
 17.5 cm / 7"  
 11 mm

# Rhinology

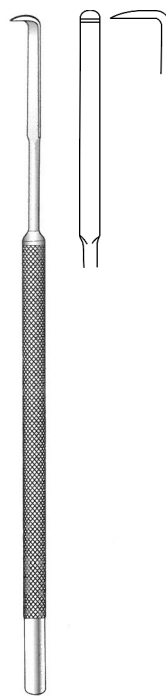
Cleft Palate Instruments  
Gaumenspalten Instrumente  
Instrumentos paladares



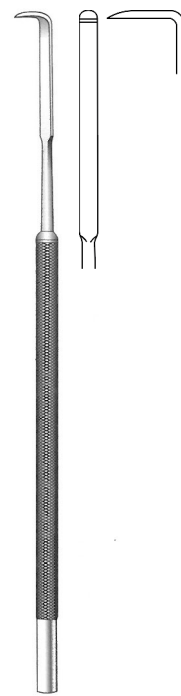
Salyer  
**V-032-2140**  
18.5 cm / 7¼"  
Cleft palate hooklets  
Short blade



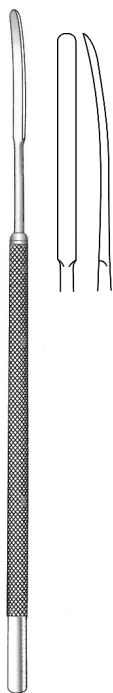
Salyer  
**V-032-2150**  
18.5 cm / 7¼"  
Cleft palate hooklet  
Long blade



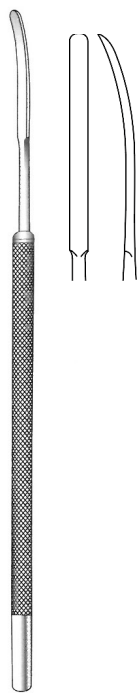
Salyer  
**V-032-2160**  
18 cm / 7"  
Cleft palate dissector  
Nasal



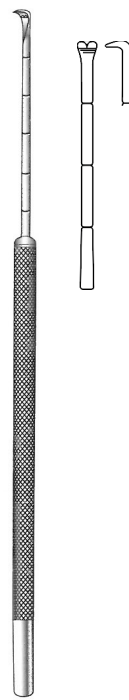
Salyer  
**V-032-2170**  
18 cm / 7"  
Cleft palate dissector  
Nasal



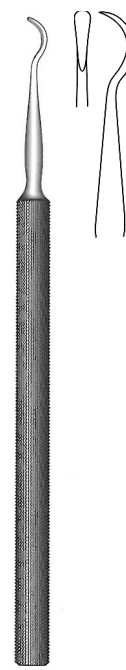
Salyer  
**V-032-2180**  
18 cm / 7"  
Cleft palate instruments



Salyer  
**V-032-2190**  
18 cm / 7"  
Cleft palate elevator



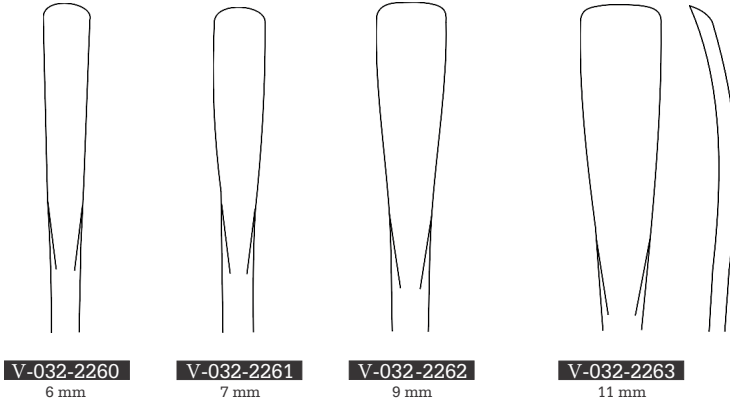
Salyer  
**V-032-2200**  
18 cm / 7"  
Cleft palate elevator



Jaboma  
**V-032-2210**  
17 cm / 6¾"  
Cleft palate periosteal elevator



Obwegeser  
 18 cm / 7"  
 Angled cutting

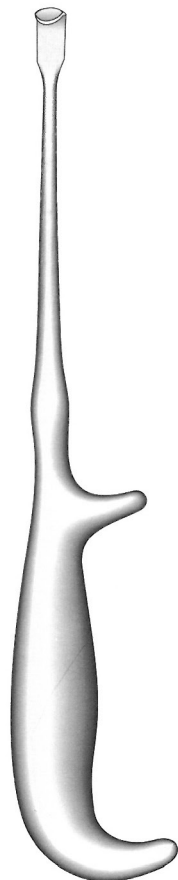


V-032-2260  
 6 mm

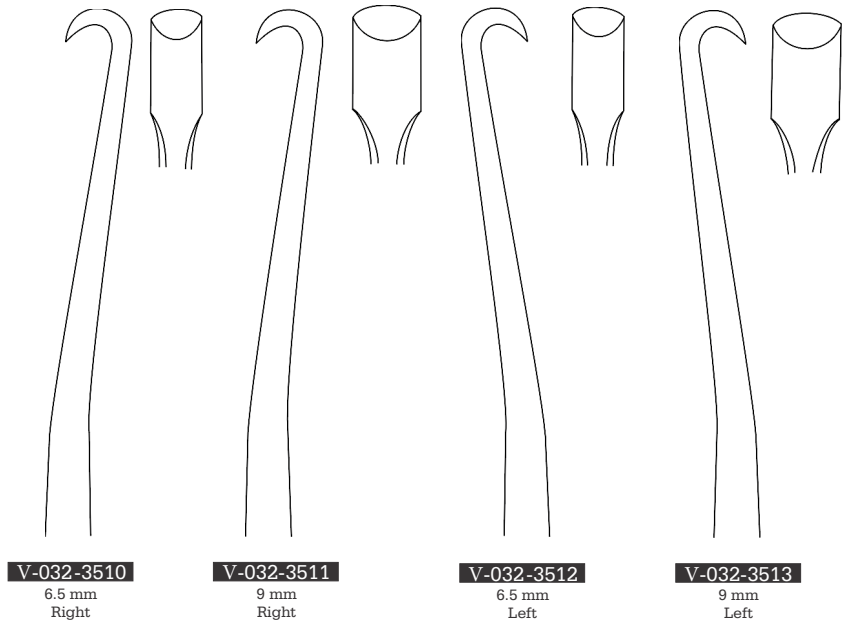
V-032-2261  
 7 mm

V-032-2262  
 9 mm

V-032-2263  
 11 mm



Hargis  
 23 cm / 9"



V-032-3510  
 6.5 mm  
 Right

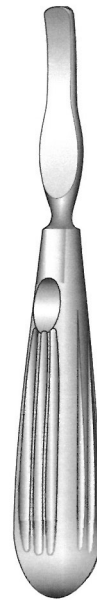
V-032-3511  
 9 mm  
 Right

V-032-3512  
 6.5 mm  
 Left

V-032-3513  
 9 mm  
 Left

# Rhinology

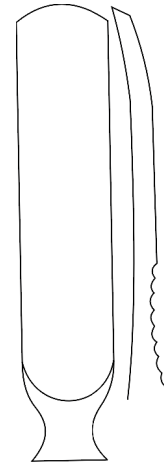
Periosteal Elevators  
Raspatorien  
Legras para periostio



Marchac  
15.5 cm / 6"



V-032-2350  
7.5 mm



V-032-2351  
12 mm



Marchac  
17 cm / 6 3/4"



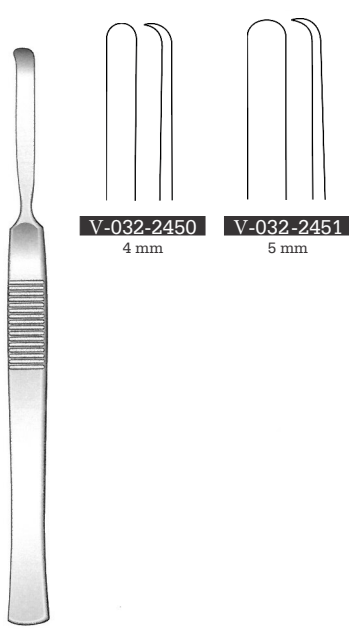
V-032-2360  
2 mm



V-032-2361  
3.5 mm



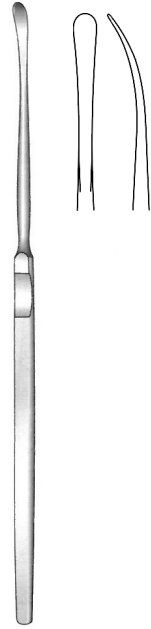
V-032-2362  
5 mm



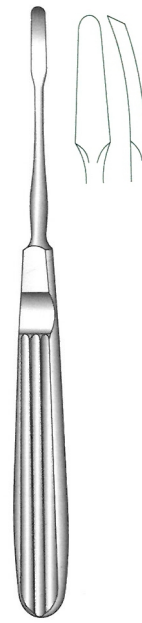
McKenty  
15 cm / 6"

V-032-2450  
4 mm

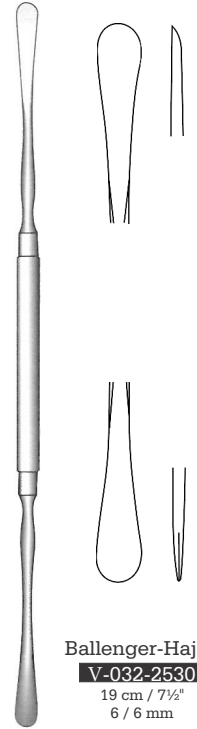
V-032-2451  
5 mm



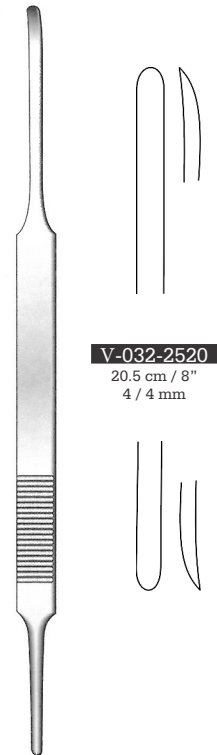
Halle  
V-032-2460  
16 cm / 6 1/4"  
3.5 mm



Joseph  
V-032-2470  
16 cm / 6 1/4"  
4 mm  
Light curve wide blade



Ballenger-Hajek  
V-032-2530  
19 cm / 7 1/2"  
6 / 6 mm



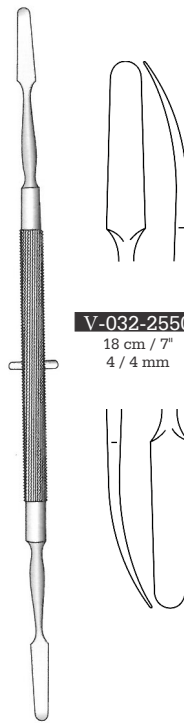
McKenty

V-032-2520  
20.5 cm / 8"  
4 / 4 mm



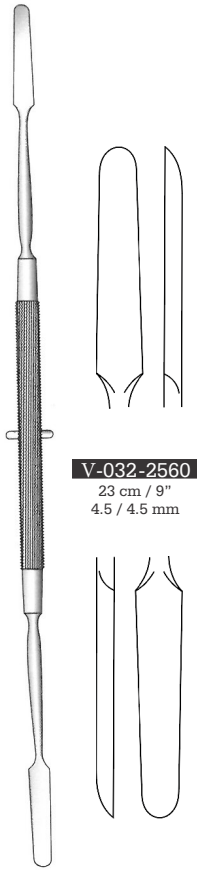
Cottle

V-032-2540  
23.5 cm / 9 1/4"  
5 / 5 mm



Killian

V-032-2550  
18 cm / 7"  
4 / 4 mm



Killian

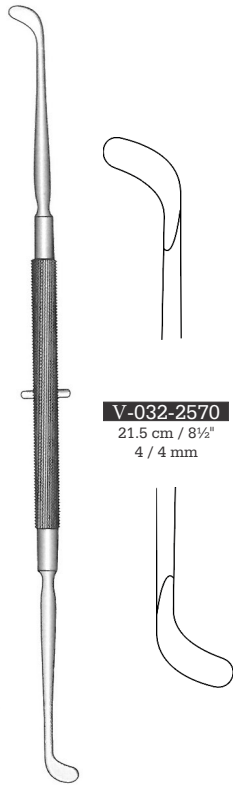
V-032-2560  
23 cm / 9"  
4.5 / 4.5 mm

# Rhinology

Septum Elevators, Periosteal Elevators

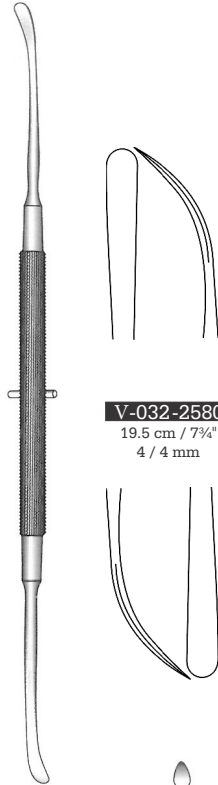
Septumelevatorenien, Periostelevatorien

Elevadores para tabique nasal, Legras para periostio



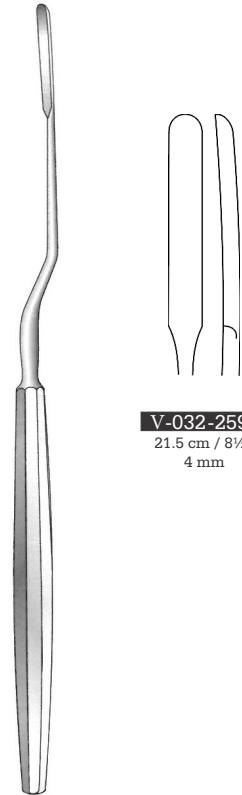
**V-032-2570**  
21.5 cm / 8½"  
4 / 4 mm

Pennington



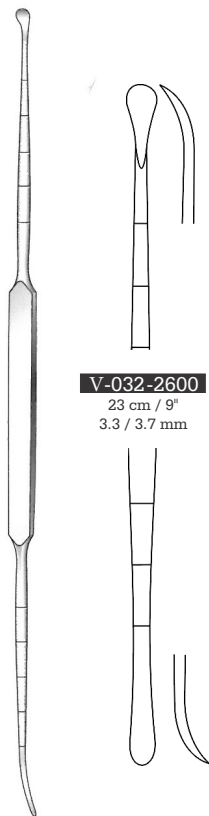
**V-032-2580**  
19.5 cm / 7¾"  
4 / 4 mm

Roger



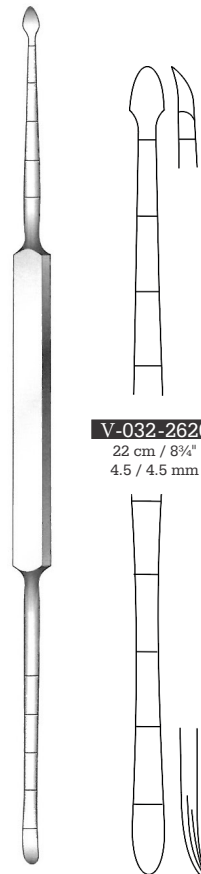
**V-032-2590**  
21.5 cm / 8½"  
4 mm

Joseph-Masing



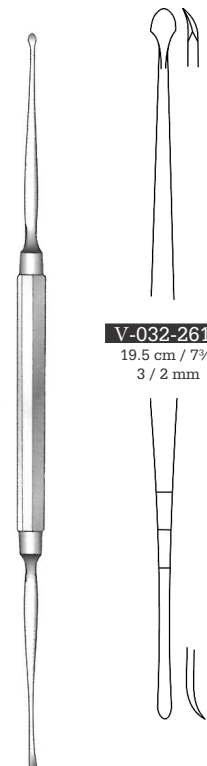
**V-032-2600**  
23 cm / 9"  
3.3 / 3.7 mm

Cottle



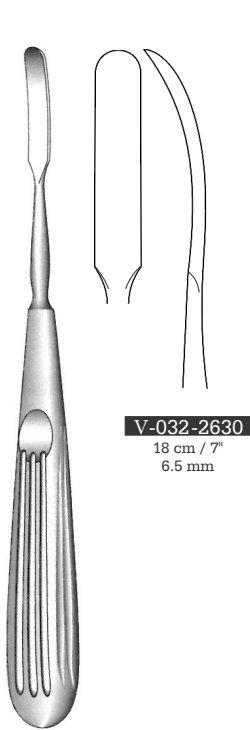
**V-032-2620**  
22 cm / 8¾"  
4.5 / 4.5 mm

Cottle



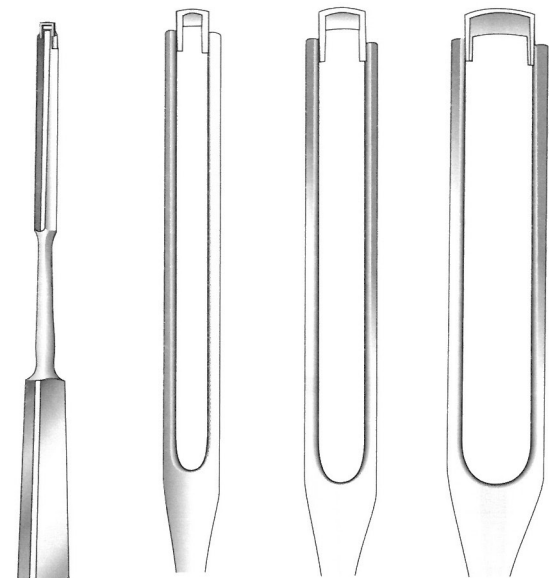
**V-032-2610**  
19.5 cm / 7¾"  
3 / 2 mm

Masing



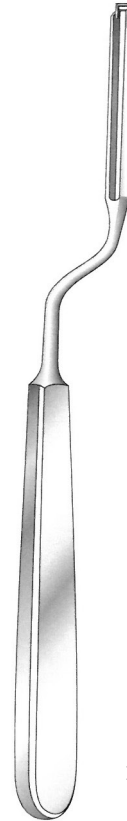
**V-032-2630**  
 18 cm / 7"  
 6.5 mm

Joseph



**V-032-1340**   **V-032-1360**   **V-032-1380**   Straight  
**V-032-1350**   **V-032-1370**   **V-032-1390**   Angled  
 3 mm                      4 mm                      5 mm

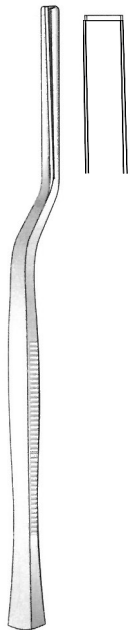
Ballenger  
 21 cm / 8 1/4"  
 Straight



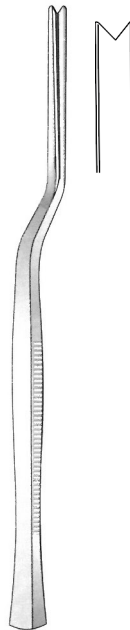
Ballenger  
 20 cm / 8"  
 Angled



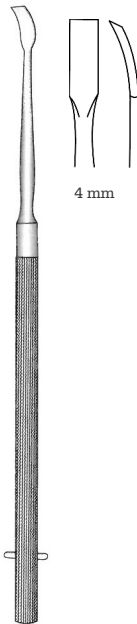
Ballenger  
**V-032-1400**  
 15 cm / 6"



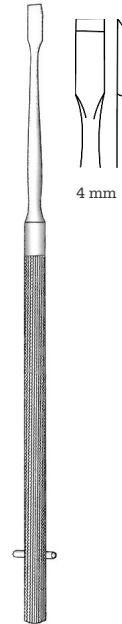
Killian  
**V-032-1410**  
 16 cm / 6 1/4"  
 5 mm



Killian-Claus  
**V-032-1420**  
 16 cm / 6 1/4"  
 5 mm



Freer  
**V-032-1430**  
 18 cm / 7"



Freer  
**V-032-1440**  
 18 cm / 7"



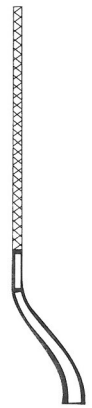
Joseph  
 19 cm / 7 1/2"  
 Working length 40 mm



**V-032-1450**  
 Curved to right



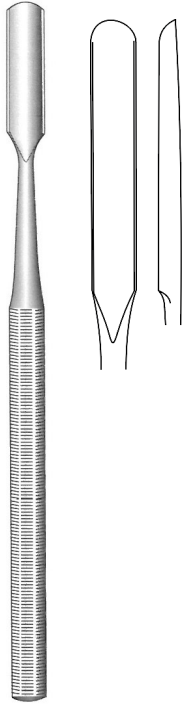
**V-032-1455**  
 Straight



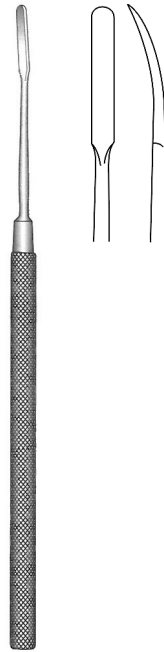
**V-032-1460**  
 Curved to left

# Rhinology

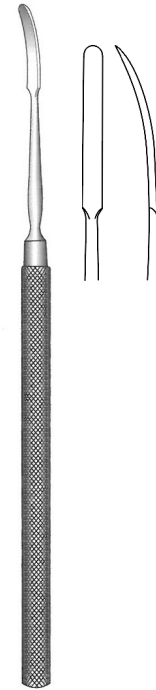
Septum Gouges & Periosteal Elevators, Nasal Saws  
Septum-Hohmeißel und Raspatorien, Nasensagen  
Gubias para tabique nasal Y Legras, Sierras nasales



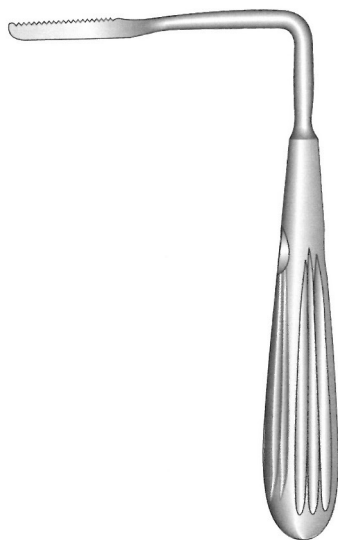
**Freer**  
**V-032-2640**  
15 cm / 6"  
6 mm  
Septum gouges



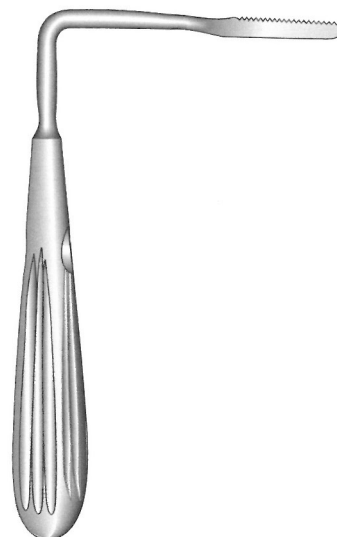
**V-032-2650**  
18 cm / 7"  
3 x 18 mm



**V-032-2660**  
18 cm / 7"  
3.5 x 23 mm



**Joseph**  
**V-032-1470**  
17 cm / 6 3/4"  
Angled to left  
Nasal knife



**Joseph**  
**V-032-1480**  
17 cm / 6 3/4"  
Angled to right  
Nasal knife





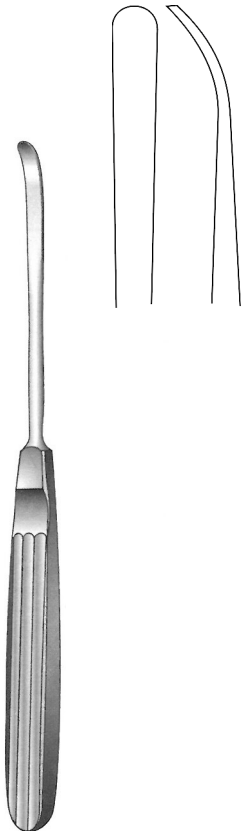
Tessier  
20.5 cm / 8"



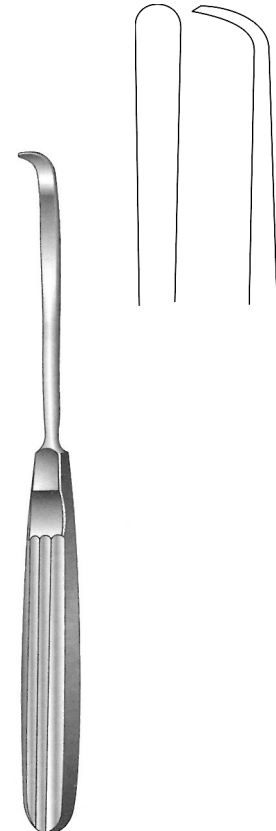
V-032-2410  
12 mm



V-032-2420  
15 mm



Tessier  
V-032-3500  
18.5 cm / 7 1/4"  
6 mm  
Angled 30°



Tessier  
V-032-3505  
18 cm / 7"  
6 mm  
Angled 60°

# Rhinology

Nasal Hooks, Nasal Retractors, Alar Hooklets

Nasenhakchen, Nasenhaken, Nasenfluegelhakchen

Ganchitos nasales, Separadores nasales, Ganchitos para alas de nariz



**Joseph**  
**V-032-1481**  
 15 cm / 6"  
 Sharp



**Cottle**  
**V-032-1482**  
 16 cm / 6 1/4"  
 Sharp



**V-032-1483**



**V-032-1484**

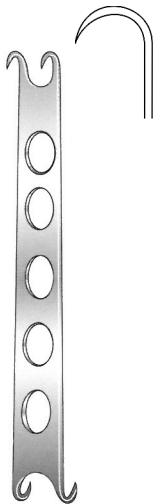


**V-032-1485**

**Cottle**  
 15 cm / 6"



**Kilner**  
**V-032-1486**  
 10 cm / 4"  
 Sharp



**Converse**  
**V-032-1487**  
 12 cm / 4 3/4"  
 Double ended  
 Sharp



**Freer**  
**V-032-1488**  
 15 cm / 6"  
 Sharp



**Joseph**  
 16 cm / 6 1/4"



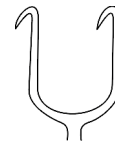
**V-032-1489**  
 2 mm



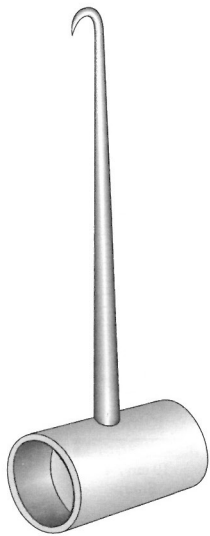
**V-032-1491**  
 5 mm



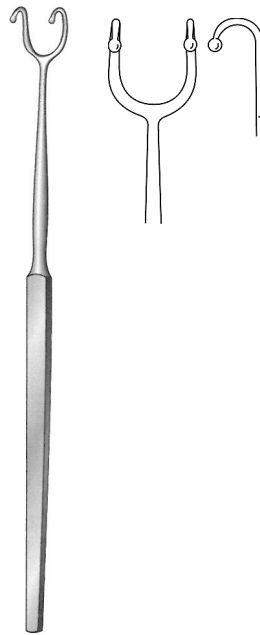
**V-032-1492**  
 7 mm



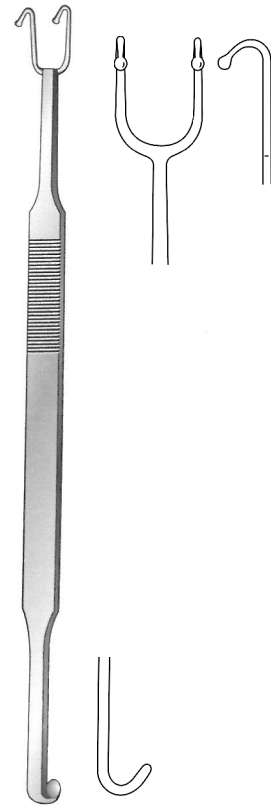
**V-032-1493**  
 10 mm



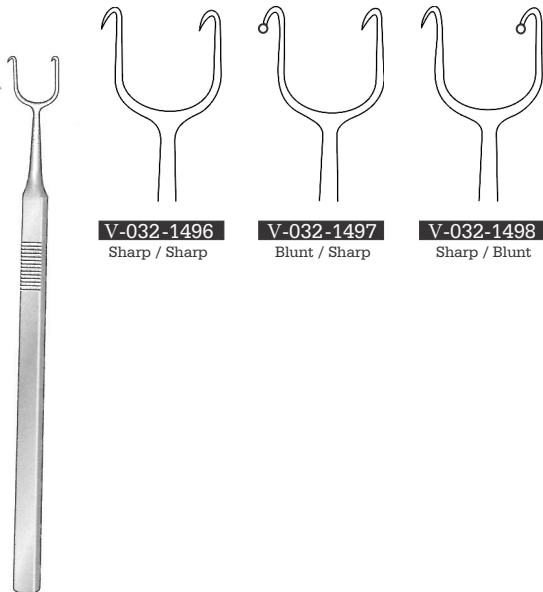
Weighted Nasal Hook  
**V-030-320**  
 Approx. weight, 2oz  
 Nasal hook



Fomon  
**V-032-1494**  
 16 cm / 6 1/4"



Cottle-Neivert  
**V-032-1495**  
 20 cm / 8"

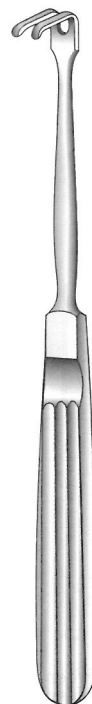


Cottle  
 15 cm / 6"

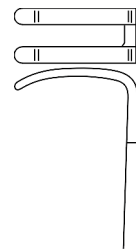
**V-032-1496**  
 Sharp / Sharp

**V-032-1497**  
 Blunt / Sharp

**V-032-1498**  
 Sharp / Blunt



18.5 cm / 7 1/4"



**V-032-2670**  
 14 x 17 mm  
 Koberg. mod  
**V-032-2671**  
 20 x 7 mm

# Rhinology

Wire Pushers, Arch Bar, Zygoma Elevators

Drahtpositionierer, Drahtbogen, Zygoma Elevatorien

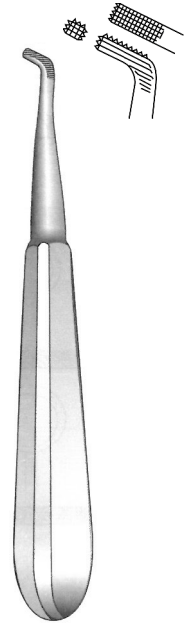
Empujadores de alambres, Arco de alambre, Elevadores cigomaticos



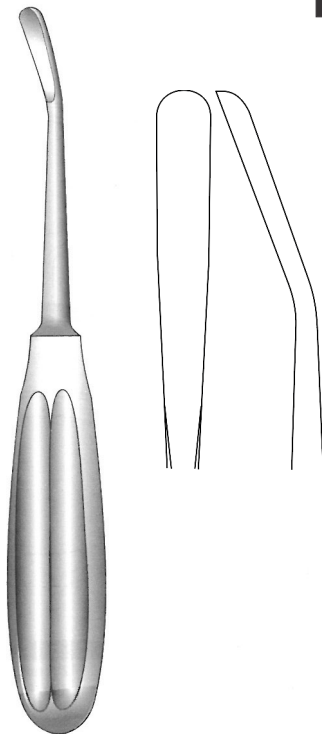
**V-032-2680**  
17 cm / 6 3/4"



**Rowe**  
**V-032-2685**  
15 cm / 6"



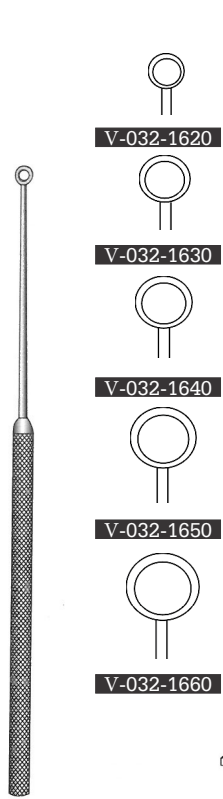
**Mershon**  
**V-032-2686**  
15 cm / 6"



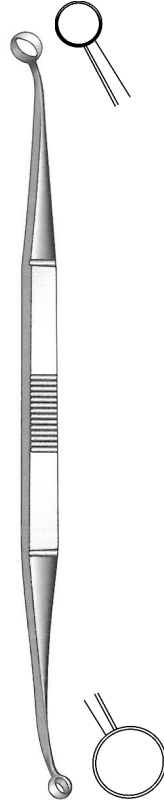
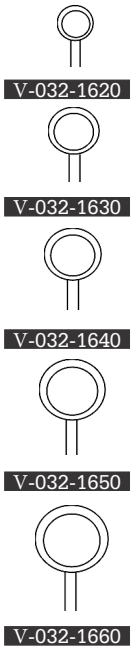
**Gillies**  
**V-032-2430**  
20 cm / 8"



**Dingmann**  
**V-032-2440**  
21 cm / 8 1/4"  
Tip 5.0 mm $\varnothing$



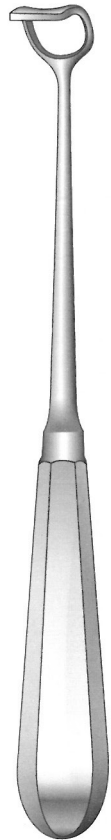
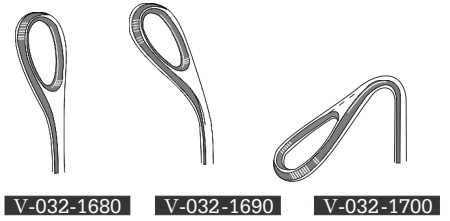
Myles  
17 cm / 6¾"



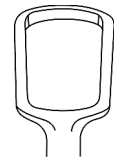
Faulkner  
V-032-1670  
21 cm / 8¼"



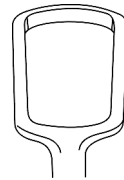
Coakley  
17 cm / 6¾"



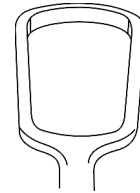
Beckmann  
22 cm / 8¾"  
Trapezoidal fenestrated



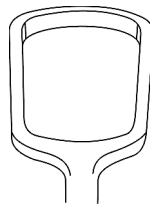
V-032-1780  
16 mm  
Fig. 1



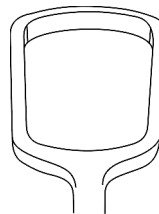
V-032-1790  
17 mm  
Fig. 2



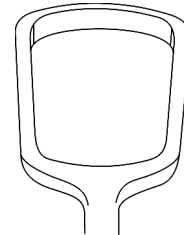
V-032-1800  
18 mm  
Fig. 3



V-032-1810  
20 mm  
Fig. 4



V-032-1820  
21 mm  
Fig. 5



V-032-1830  
23 mm  
Fig. 6

# Rhinology

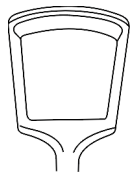
Adenoid Curettes, Bone Curettes, Curette Sharpener

Ringmesser, Scharfe Kuretten, Kurettenscharfer

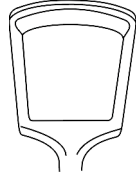
Cuchillos para Vegetaciones adenoides, Curetatas cortantes, Afilador para curetas



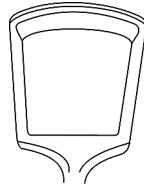
**Beckmann**  
22 cm / 8 3/4"



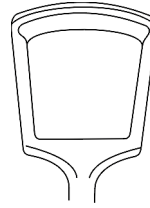
**V-032-1840**  
Fig. 1



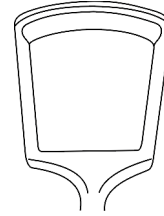
**V-032-1850**  
Fig. 2



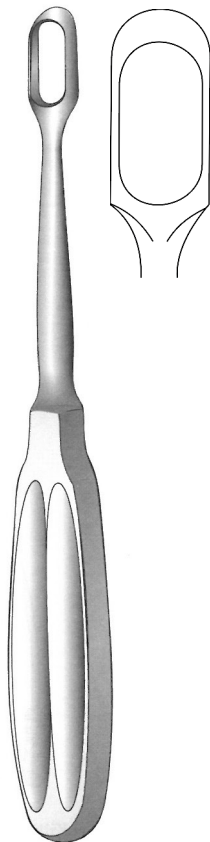
**V-032-1860**  
Fig. 3



**V-032-1870**  
Fig. 4



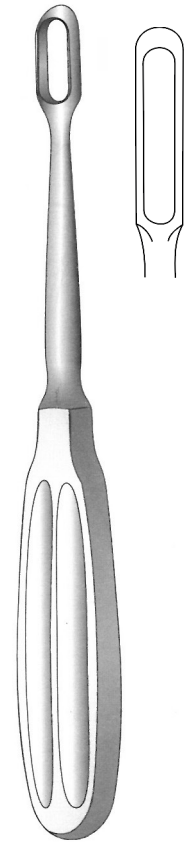
**V-032-1880**  
Fig. 5



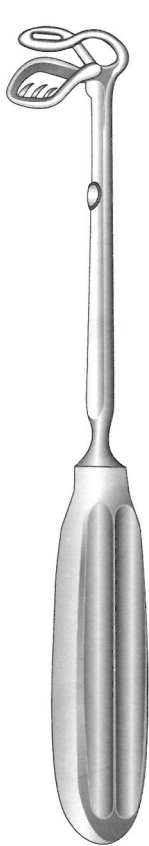
**Tessier**  
**V-032-1882**  
21.5 cm / 8 1/2"  
12 mm



**Tessier**  
**V-032-1950**  
19.5 cm / 7 3/4"  
Curette sharpener



**Tessier**  
**V-032-1884**  
21.5 cm / 8 1/2"  
6 mm



**St. Clair-Thomson**  
21 cm / 8 1/4"



**V-032-1890**  
11 mm



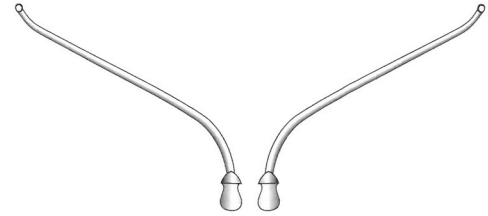
**V-032-1900**  
13 mm



**V-032-1910**  
15 mm



**V-032-1920**  
17 mm

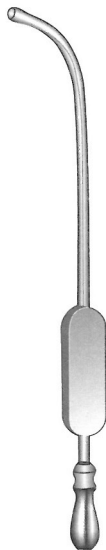


**Hartmann**

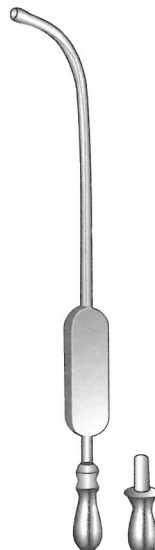
Fig. 1	mmØ	Fig. 2
V-032-1960	2	V-032-1990
V-032-1970	2.5	V-032-2000
V-032-1980	3	V-032-2001



**Hartmann**  
**V-032-2010** 2 mm Ø  
**V-032-2020** 2.5 mm Ø  
**V-032-2030** 3 mm Ø  
 12 cm / 4 3/4"



**Eicken-Killian**  
**V-032-2040**  
 14 cm / 5 1/2"  
 3 mm Ø  
 Irrigation cannula



**Eicken-Killian**  
**V-032-2050**  
 14 cm / 5 1/2"  
 3 mm Ø



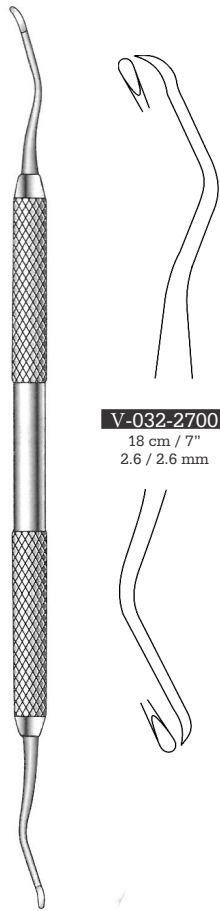
**Killian**  
**V-032-2060**  
 17 cm / 6 3/4"  
 1.5 mm Ø



**Marchac**  
**V-032-2065**  
 19 cm / 7 1/2"

# Oral Maxillo Facial Surgery

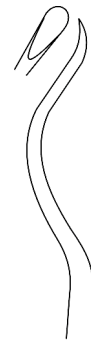
Sinus Lift Currettes  
Sinus Lift Kuretten  
Curetas para Sinus-lift



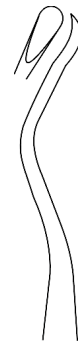
**V-032-2700**  
18 cm / 7"  
2.6 / 2.6 mm



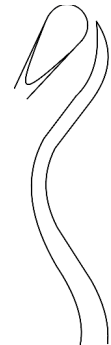
**V-032-2710**  
17.5 cm / 7"  
2.6 / 2.6 mm



**V-032-2711**  
18 cm / 7"  
4.1 / 4.1 mm



**V-032-2712**  
18.5 cm / 7 1/4"  
4.1 / 4.1 mm



**V-032-2714**  
19 cm / 7 1/2"  
6.7 / 6.7 mm



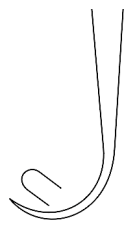
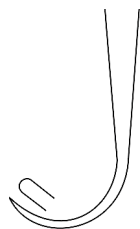
**V-032-2713**  
18.5 cm / 7 1/4"  
6.7 / 6.7 mm



**V-032-2720**  
16 cm / 6 1/4"  
2.8 / 6.2 mm



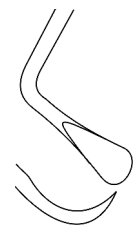
**V-032-2721**  
16 cm / 6 1/4"  
2.8 / 6.2 mm



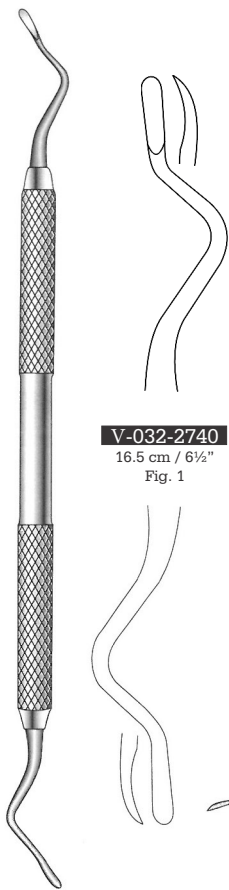
**V-032-2730**  
15 cm / 6"  
3.1 / 3.1 mm



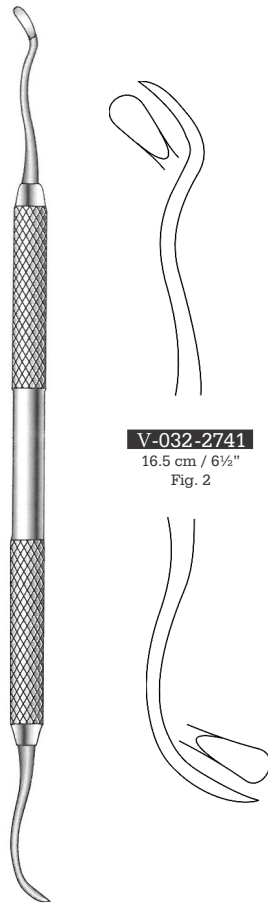
**V-032-2731**  
17 cm / 6 1/4"  
5.6 / 5.6 mm



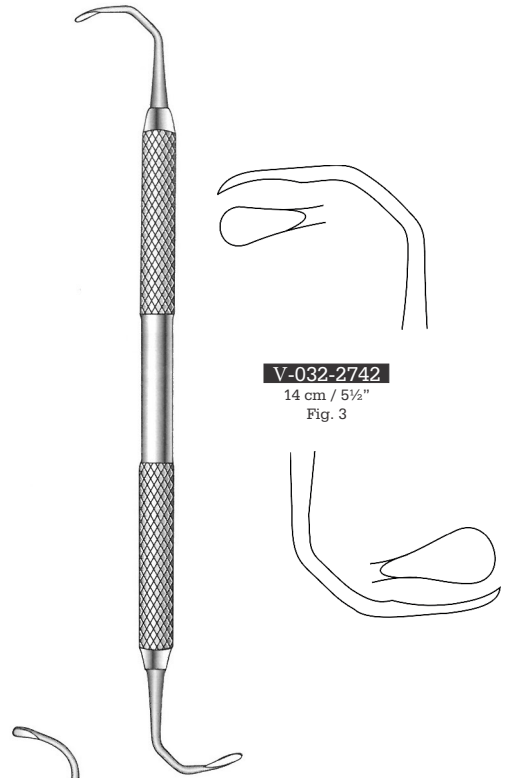




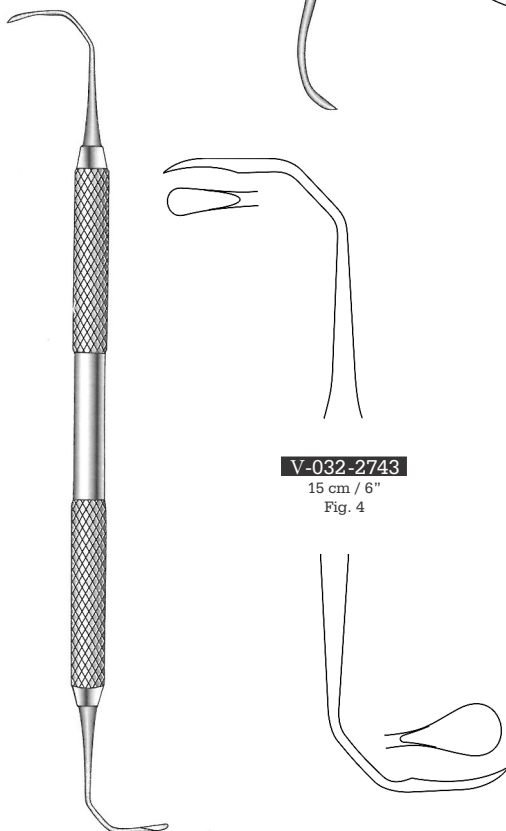
**V-032-2740**  
16.5 cm / 6½"  
Fig. 1



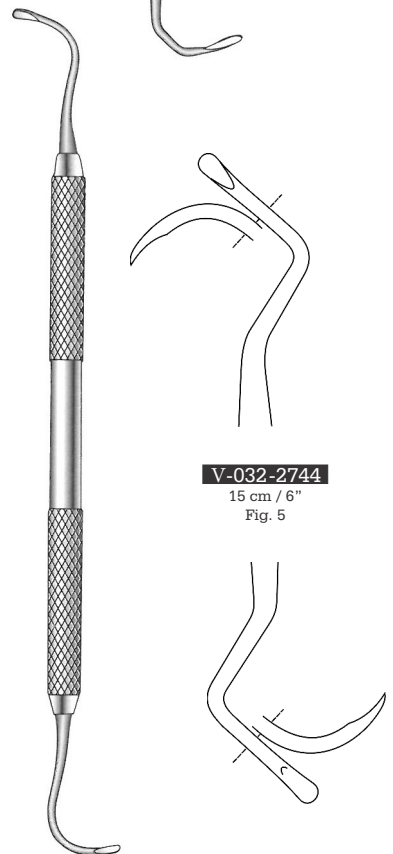
**V-032-2741**  
16.5 cm / 6½"  
Fig. 2



**V-032-2742**  
14 cm / 5½"  
Fig. 3



**V-032-2743**  
15 cm / 6"  
Fig. 4



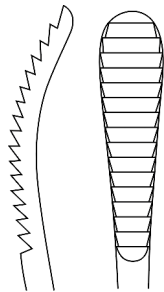
**V-032-2744**  
15 cm / 6"  
Fig. 5

# Rhinology

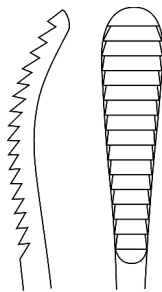
Glabella Rasps, Nasal Rasps, Bone Files  
 Glabellaraspeeln, Nasenraspel, Knochenfeilen  
 Escofinas para glabella, nasales, Limas Para Huesos



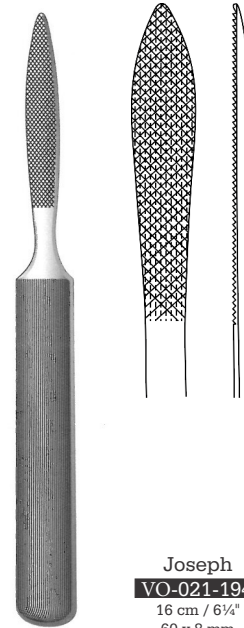
**Aufricht**  
 21 cm / 8¼"



**VO-021-191**  
 Single ended  
 forward cutting  
 32 x 9 mm



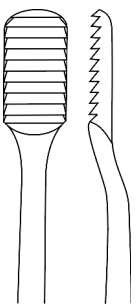
**VO-021-192**  
 Single ended  
 backward cutting  
 32 x 9 mm



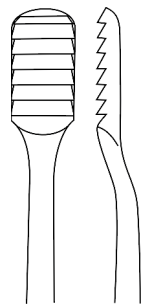
**Joseph**  
**VO-021-194**  
 16 cm / 6¼"  
 60 x 8 mm  
 Single ended, 8 mm at wide  
 point, fine cross serrations



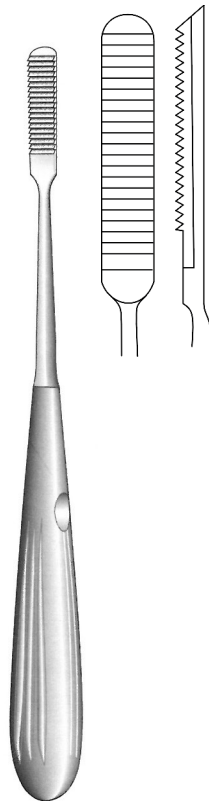
**Lewis**  
 19 cm / 7½"



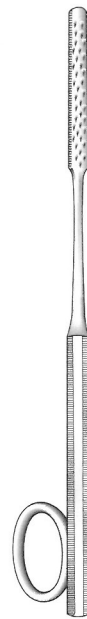
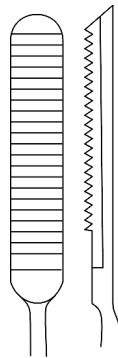
**VO-021-195**  
 Fine, single ended  
 15 x 8 mm



**VO-021-196**  
 Coarse, single ended  
 15 x 8 mm  
 Plain serrations



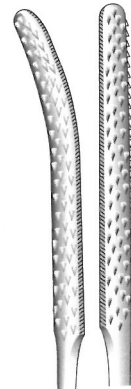
**Cottle**  
**VO-021-197**  
 21 cm / 8¼"  
 30 x 8 mm



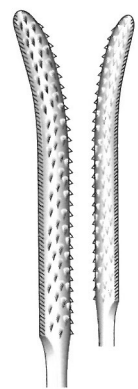
**Gallaher**  
 17 cm / 6¾"



**V-032-1535**  
 45 x 6 mm



**V-032-1536**  
 45 x 6 mm

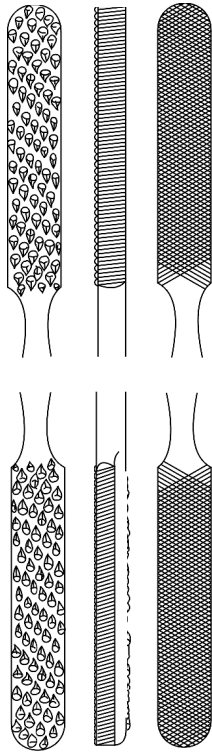


**V-032-1537**  
 45 x 6 mm

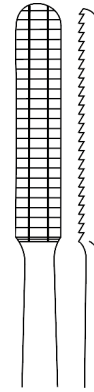


**Fomon**  
**VO-021-189**  
21 cm / 8 1/4"

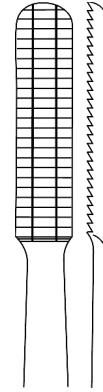
Double ended, fine and coarse teeth 4-side, convex and flat blades 30 x 8 mm



**Maltz**  
18 cm / 7"  
Single ended  
10 mm width



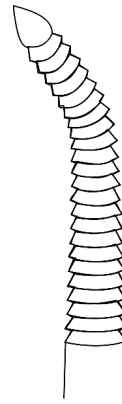
**VO-021-193**  
034 x 7 mm  
Backward cutting



**V-021-1541**  
34 x 7 mm  
Forward cutting



**Wiener**  
18 cm / 7"



**V-032-1520**



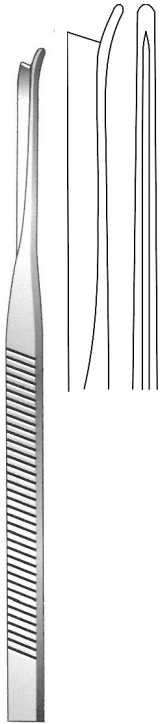
**V-032-1530**

# Rhinology

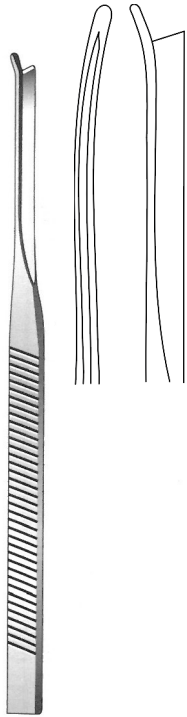
Rhinoplastic Chisels & Osteotomes

Nasenmeißel und Osteotome

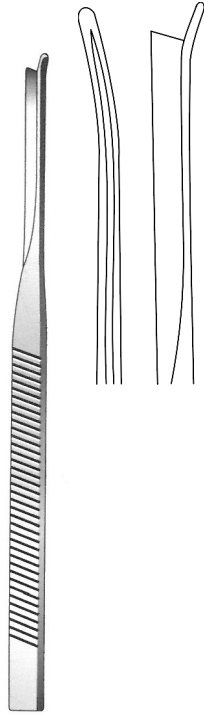
Cinceles nasales Y Osteotomos



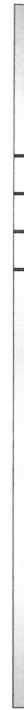
**Silver**  
**V-032-1571**  
18 cm / 7"  
Straight



**Silver**  
**V-032-1572**  
18 cm / 7"  
Right



**Silver**  
**V-032-1573**  
18 cm / 7"  
Left



**V-032-1574**  
4 mm



**V-032-1575**  
7 mm

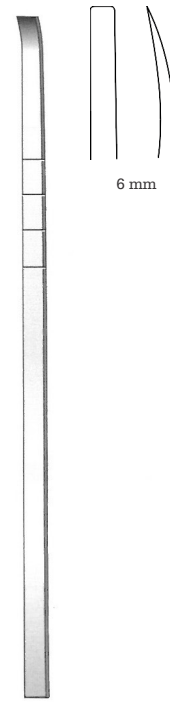


**V-032-1576**  
9 mm

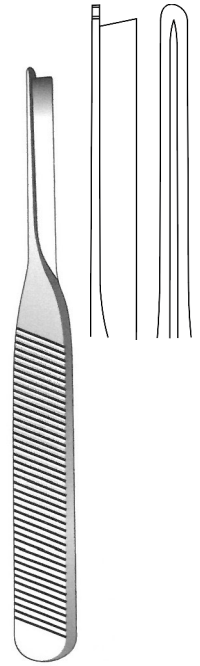


**V-032-1577**  
12 mm

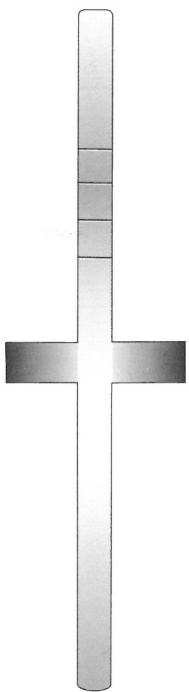
**Cottle**  
18 cm / 7"  
Osteotome



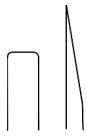
**Cottle**  
**V-032-1578**  
18 cm / 7"  
Osteotome



**Parkes**  
**V-032-2800**  
16 cm / 6 1/4"



**Cottle**  
18 cm / 7"  
T Handle osteotome  
Very delicate



**V-032-1579**  
4 mm



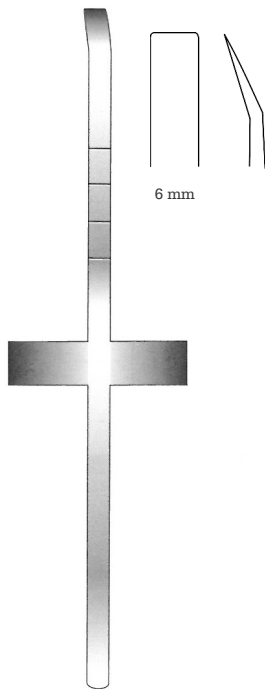
**V-032-1581**  
7 mm



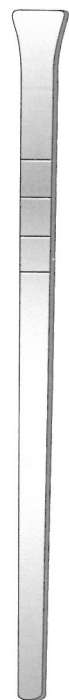
**V-032-1582**  
9 mm



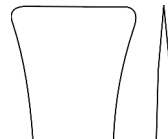
**V-032-1583**  
12 mm



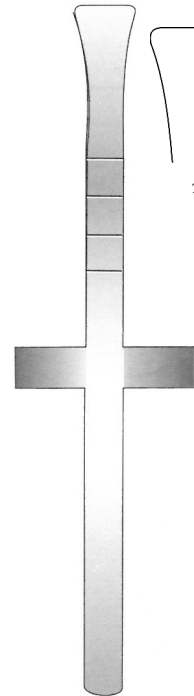
**Cottle**  
**V-032-1584**  
18 cm / 7"



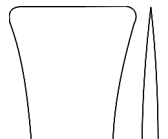
**Cottle**  
**V-032-1585**  
18 cm / 7"  
Fishtail osteotome  
Very delicate



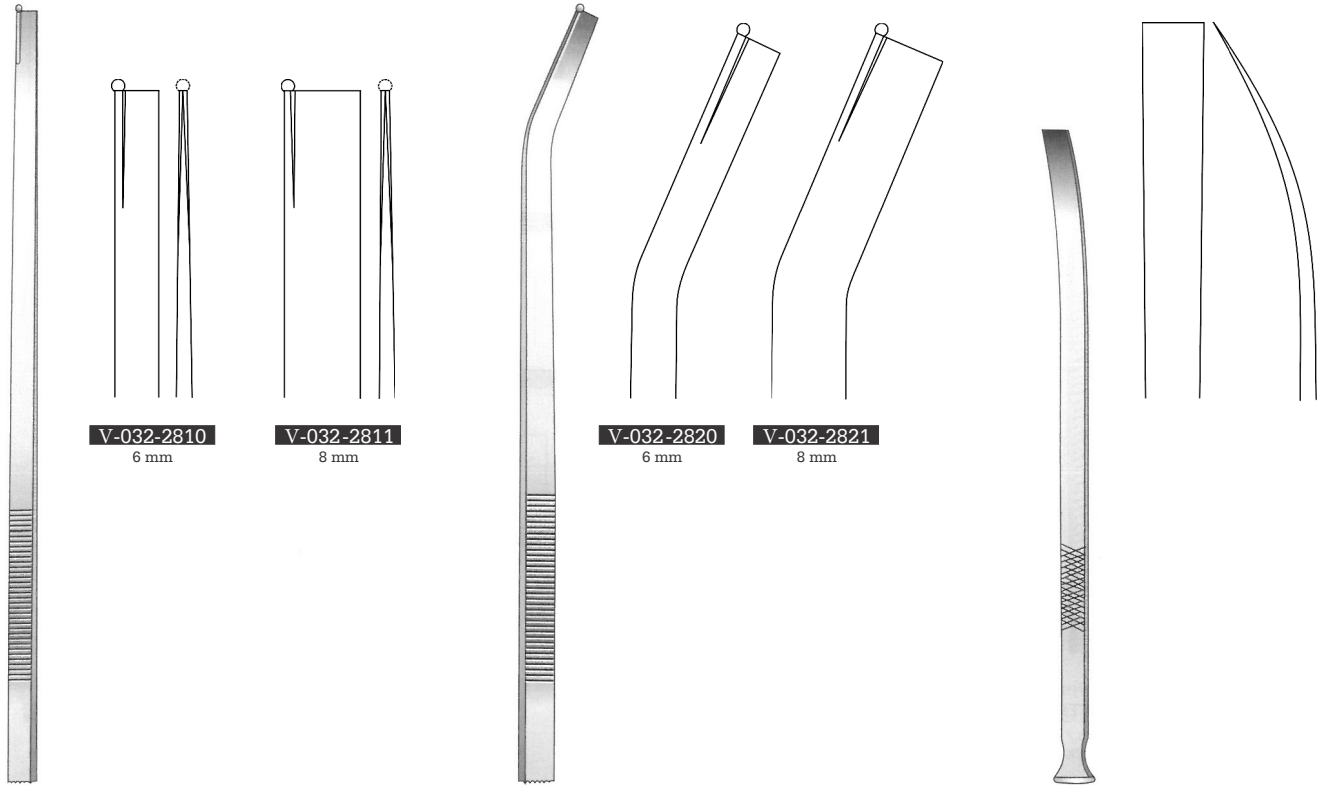
16 mm



**Cottle**  
**V-032-1586**  
18 cm / 7"



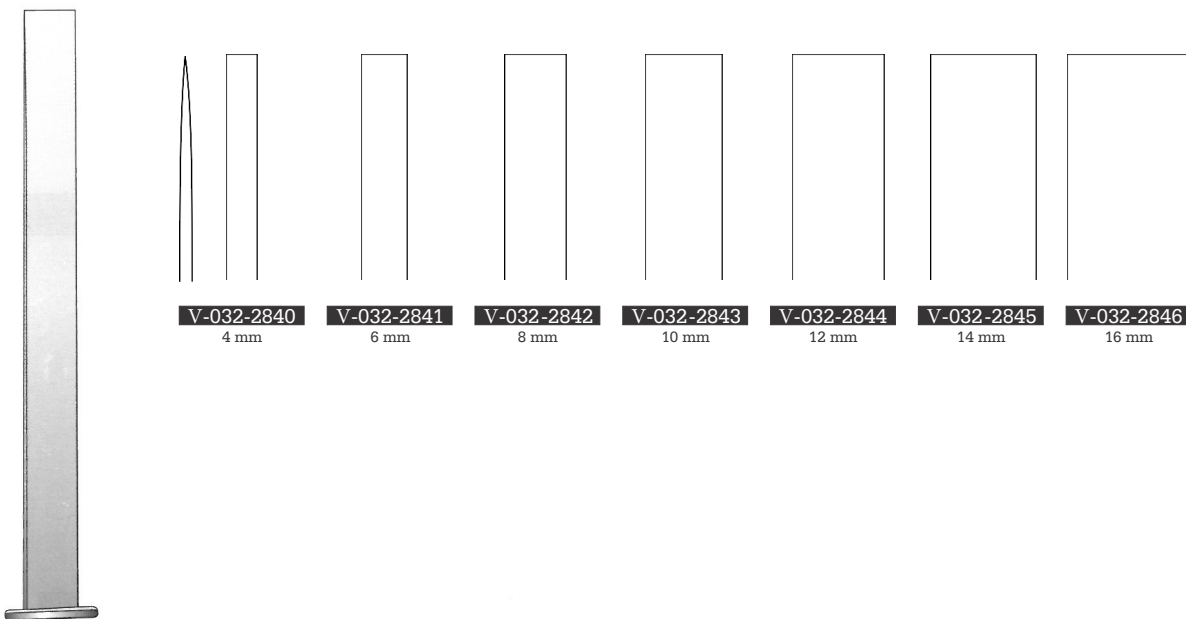
16 mm



**Bauer**  
20.5 cm / 8"

**Bauer**  
20.5 cm / 8"

**Epker Bauer**  
**V-032-2830**  
17.5 cm / 7"  
8 mm



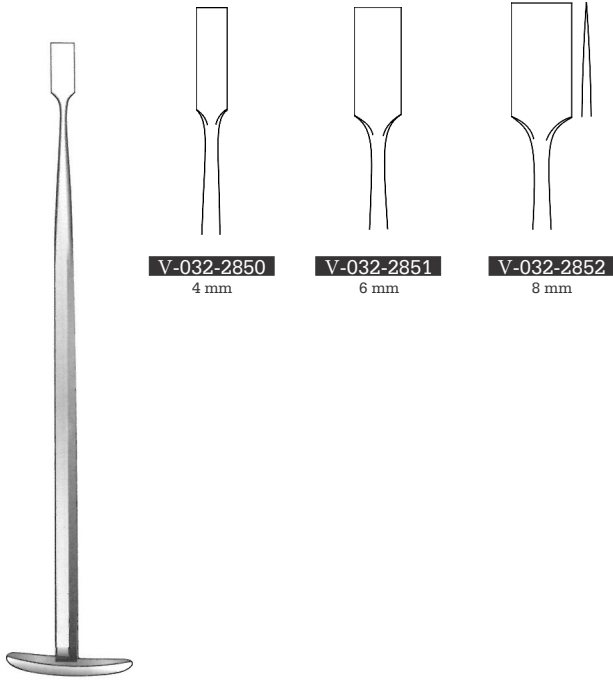
**Dautrey Munro**  
16 cm / 6 1/4"

# Rhinology

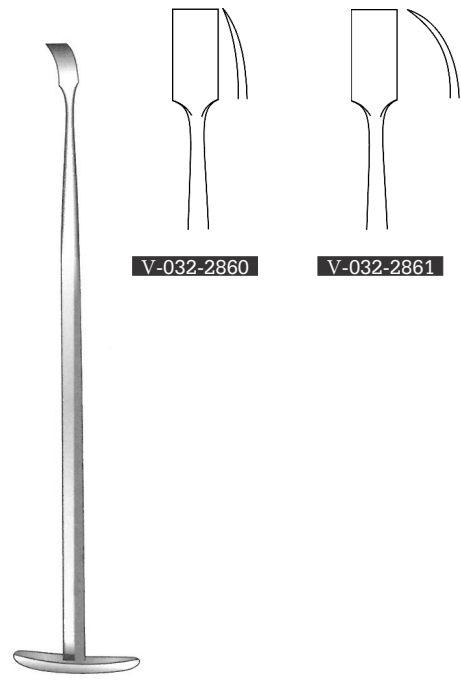
Osteotomes

Osteotome

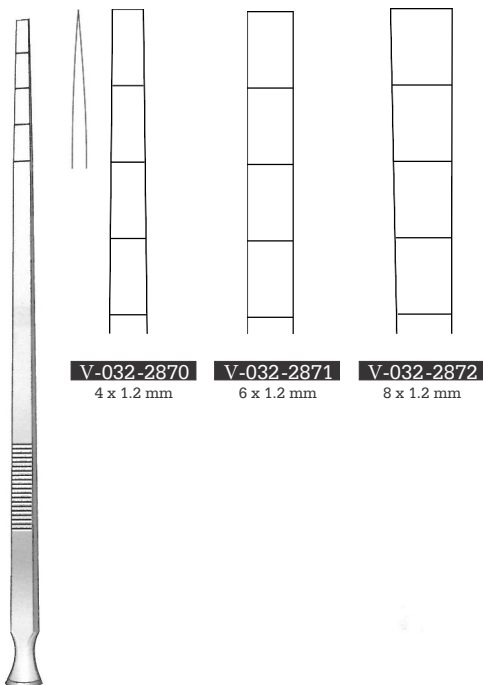
Osteotomos



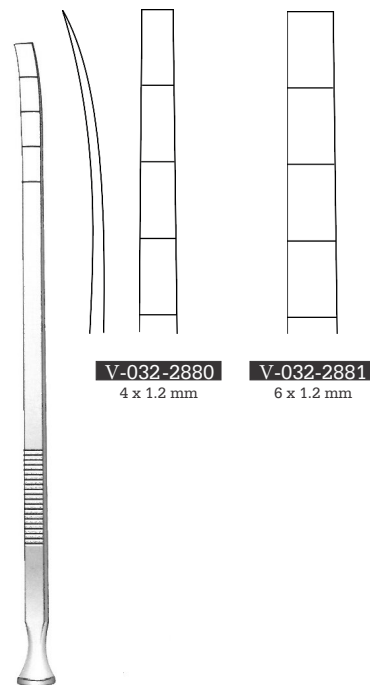
Dunn Dautrey  
16.5 cm / 6 1/2"



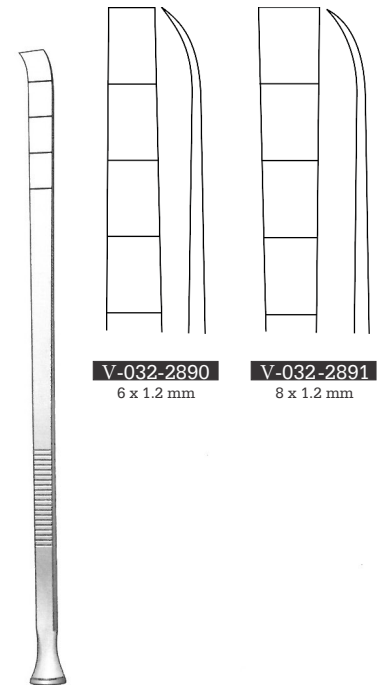
Dunn Dautrey  
17 cm / 6 3/4"  
6 mm



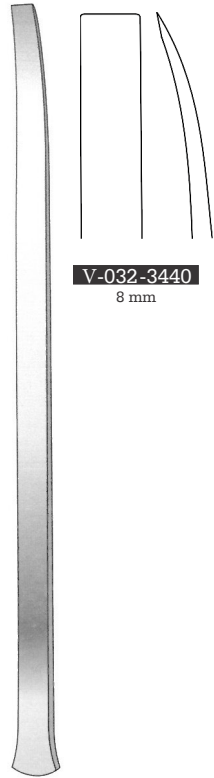
Epker  
18 cm / 7"



Epker  
18 cm / 7"

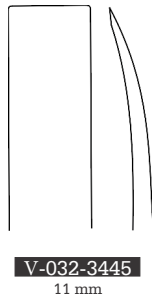


Epker  
18 cm / 7"

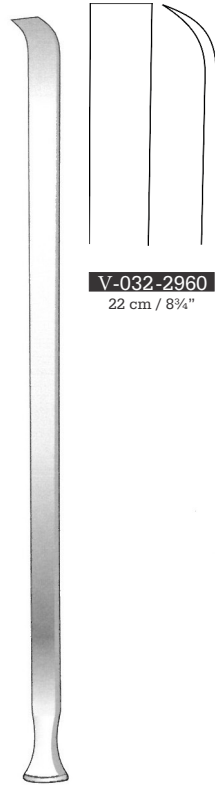


V-032-3440  
8 mm

Obwegeser  
23.5 cm / 9 1/4"

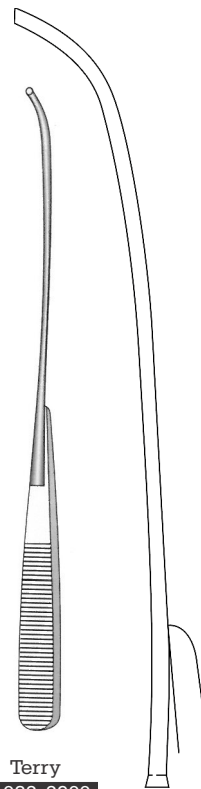


V-032-3445  
11 mm

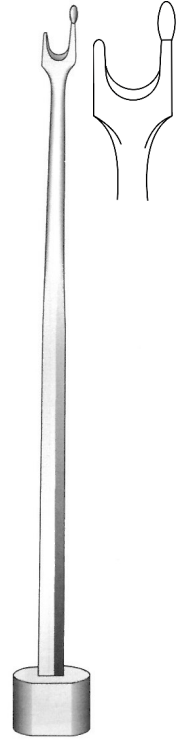


V-032-2960  
22 cm / 8 3/4"

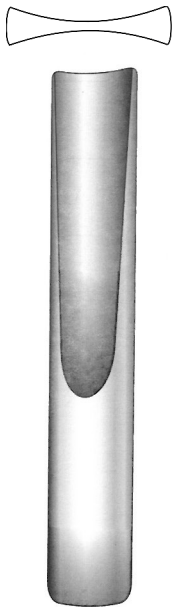
Hargis



Terry  
V-032-2900  
17 cm / 6 3/4"



Terry  
V-032-2910  
19 cm / 7 1/2"



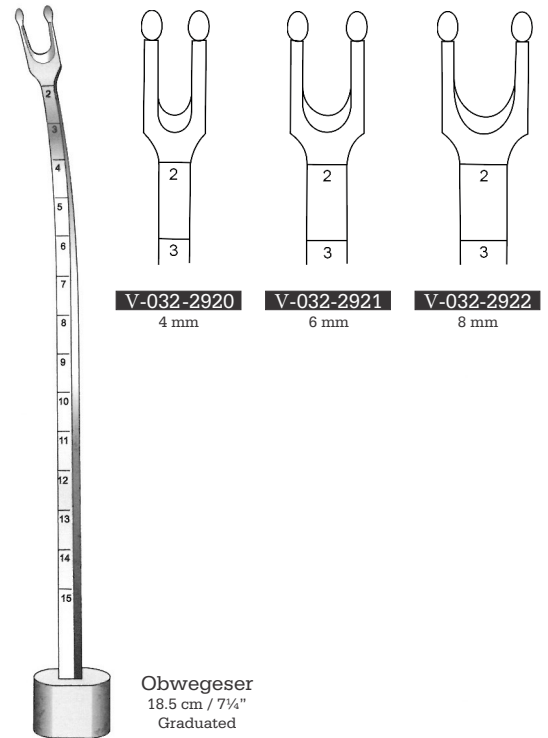
Terry  
V-032-2930  
14 cm / 5 1/2"  
Occlusal wedge



Terry  
V-032-2940  
15 cm / 6"  
Left



Terry  
V-032-2950  
15 cm / 6"  
Right



V-032-2920  
4 mm

V-032-2921  
6 mm

V-032-2922  
8 mm

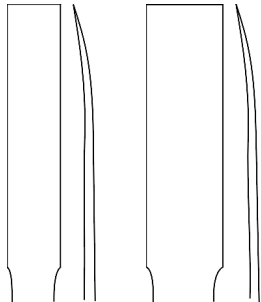
Obwegeser  
18.5 cm / 7 1/4"  
Graduated

# Rhinology

Ramus Osteotomes, Chisels

Ramusosteotome, MeiBel

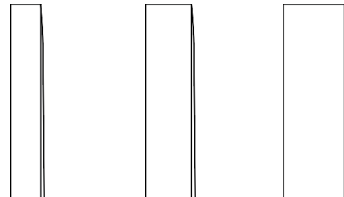
Osteotomos de rama, Cinceles



**V-032-2990**  
7 mm

**V-032-2991**  
10 mm

**Steinhauser**  
17 cm / 6 3/4"  
Flexible

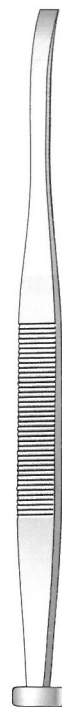


**V-032-2980**  
4 mm

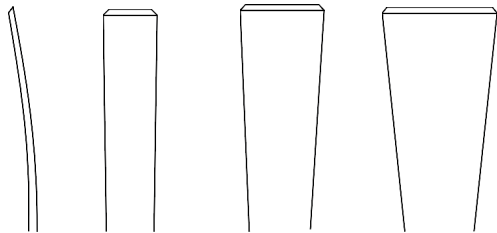
**V-032-2981**  
6 mm

**V-032-2982**  
8 mm

**Marchac**  
18.5 cm / 7 1/4"



**Marchac**  
**V-032-3520**  
18.5 cm / 7 1/4"  
6 mm  
Curved

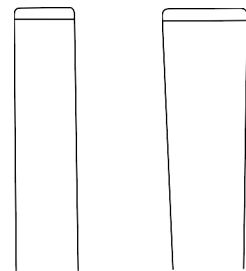
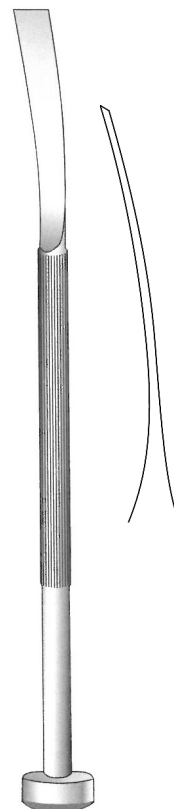


**V-032-3000**  
7 mm

**V-032-3001**  
11 mm

**V-032-3002**  
15 mm

**Steinhauser**  
19 cm / 7 1/2"  
Flexible

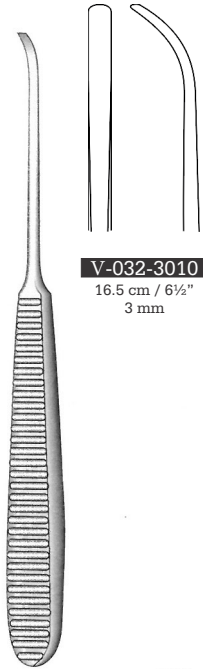


**V-032-3525**  
8 mm

**V-032-3530**  
11 mm

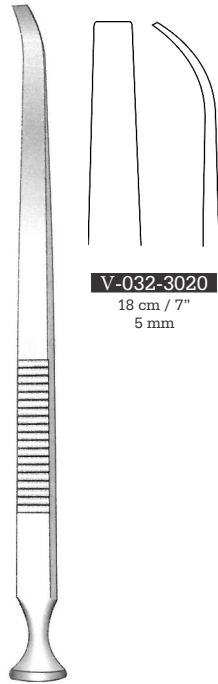
**Obwegeser**  
21 cm / 8 1/4"  
Elastic blade





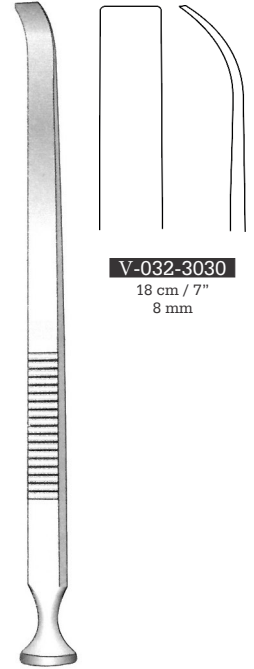
**V-032-3010**  
 16.5 cm / 6½"  
 3 mm

Steinhauser



**V-032-3020**  
 18 cm / 7"  
 5 mm

Steinhauser

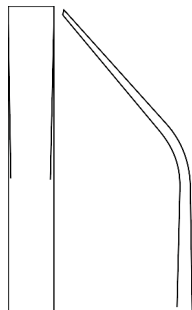


**V-032-3030**  
 18 cm / 7"  
 8 mm

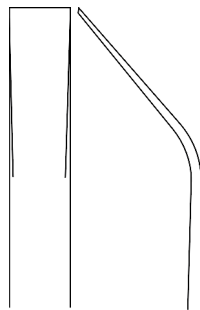
Steinhauser



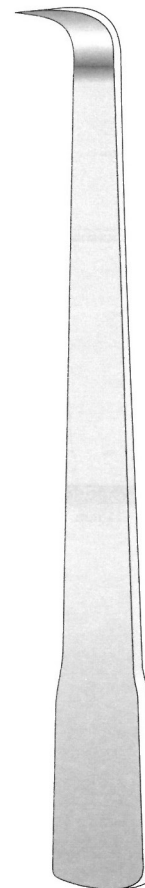
**Wolford**  
 23 cm / 9"



**V-032-3040**  
 6 mm



**V-032-3040**  
 8 mm



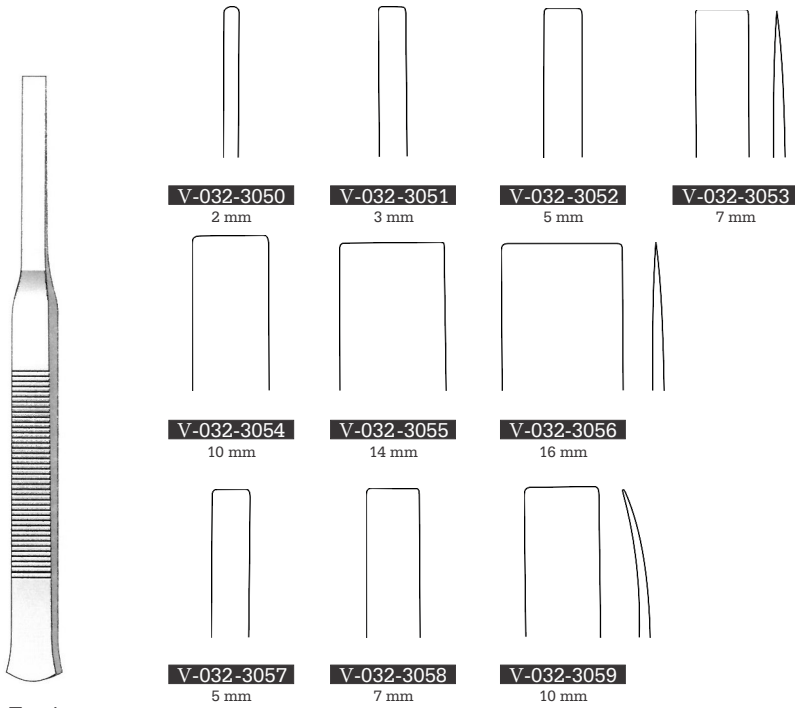
**Obwegeser**  
**V-032-2970**  
 23 cm / 9"  
 12 mm

# Rhinology

Osteotomes

Osteotome

Osteotomos



**V-032-3050**  
2 mm

**V-032-3051**  
3 mm

**V-032-3052**  
5 mm

**V-032-3053**  
7 mm

**V-032-3054**  
10 mm

**V-032-3055**  
14 mm

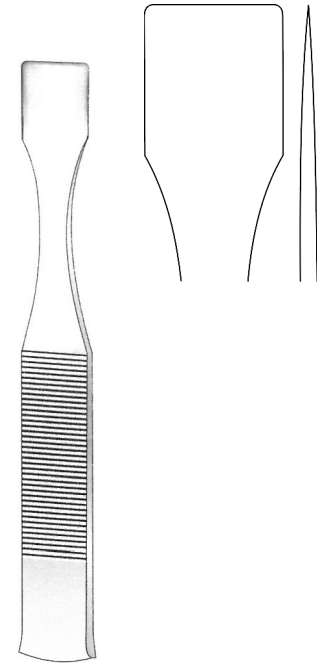
**V-032-3056**  
16 mm

**V-032-3057**  
5 mm

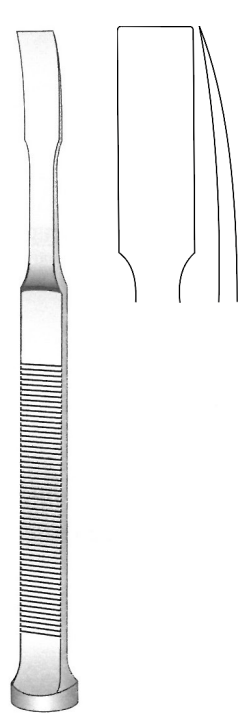
**V-032-3058**  
7 mm

**V-032-3059**  
10 mm

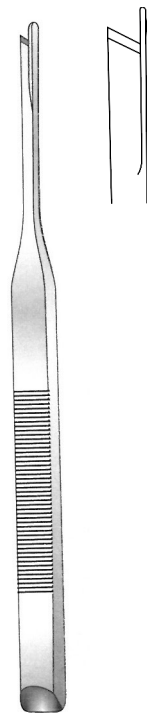
**Tessier**  
16 cm / 6¼"



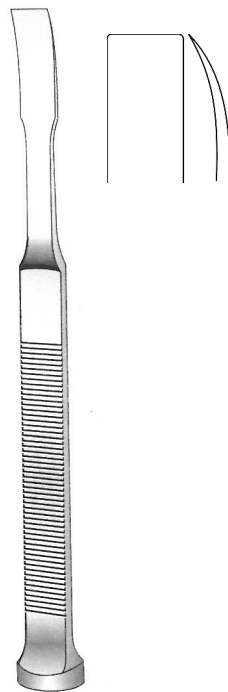
**Tessier**  
**V-032-3070**  
16 cm / 6¼"  
18 mm



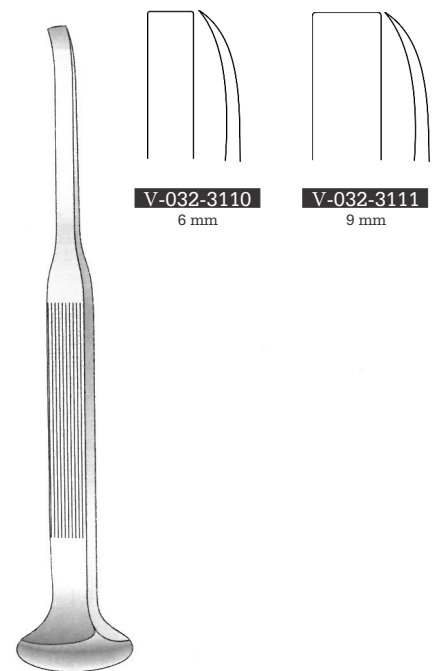
**Tessier**  
**V-032-3080**  
18 cm / 7"  
10 mm



**Tessier**  
**V-032-3090**  
18.5 cm / 7¼"  
Septonasal osteotome



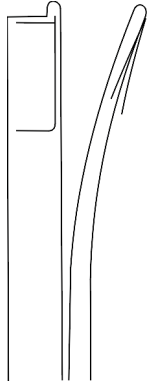
**Tessier**  
**V-032-3100**  
18 cm / 7"  
10 mm



**V-032-3110**  
6 mm

**V-032-3111**  
9 mm

**Tessier**  
16.5 cm / 6½"  
Retromaxillary chisel

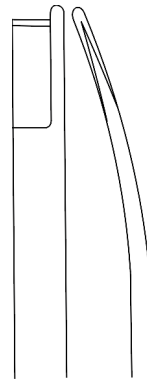


**V-032-3670**

4 mm

**V-032-3675**

7 mm

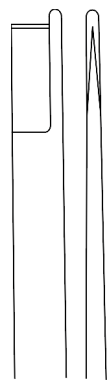


**V-032-3680**

4 mm

**V-032-3685**

7 mm



**V-032-3690**

4 mm

**V-032-3695**

7 mm



**V-032-1587**

4 mm



**V-032-1588**

5 mm



**V-032-1589**

6 mm



**V-032-1591**

7 mm

**Fomon**  
17 cm / 6 3/4"

**Neivert-Anderson**  
20.5 cm / 8"



**V-032-3130**

1 mm



**V-032-3131**

2 mm



**V-032-3132**

3 mm



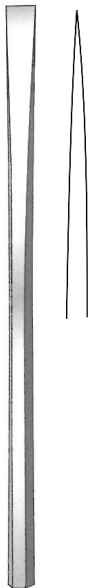
**V-032-3133**

4 mm



**V-032-3134**

5 mm



**V-032-3135**

6 mm



**V-032-3136**

7 mm



**V-032-3137**

8 mm



**V-032-3138**

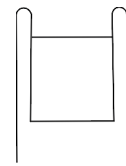
10 mm



**V-032-3139**

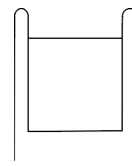
12 mm

**Sheehan**  
15 cm / 6"



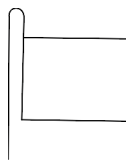
**V-032-1592**

10 mm



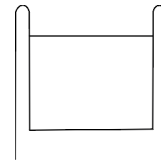
**V-032-1593**

12 mm



**V-032-1594**

14 mm



**V-032-1595**

16 mm

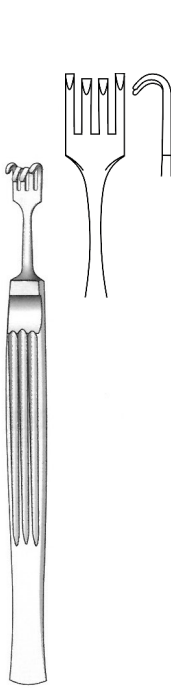
**Cinelli**  
16 cm / 6 1/4"  
Osteotome  
Double guarded

# Rhinology

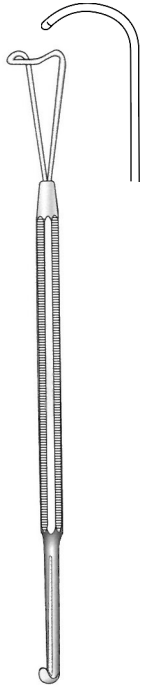
Alar Hooklets, Nasal Retractors

Nasenflügelhakchen, Nasenhaken

Ganchitos para alas de nariz, Separadores nasales



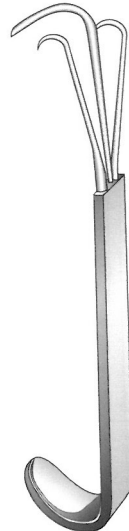
**Cottle**  
**V-032-1596**  
 14 cm / 5½"  
 Alar hooklets



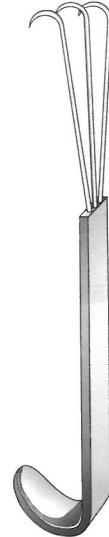
**Neivert**  
**V-032-1597**  
 16 cm / 6¼"



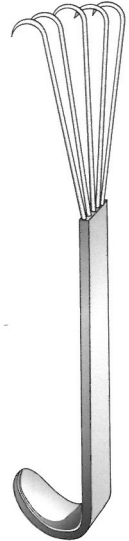
**Cottle**  
**V-032-1598**  
 15 cm / 6"  
 Saddle hook



**Becker**  
**V-032-3400** Small  
**V-032-3401** Medium  
**V-032-3402** Large  
**V-032-3403** X-Large  
 12 cm / 4¾"  
 Plastic surgery, american made  
 open retractors



**Anderson**  
 Three prong  
**V-032-3410**  
 12 cm / 4¾"  
 Short  
**V-032-3412**  
 16 cm / 6¼"  
 Long  
 Plastic surgery, american  
 made retractor



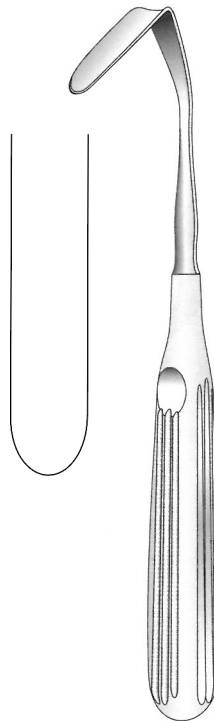
**Anderson**  
 Five prong  
**V-032-3411**  
 12 cm / 4¾"  
 Short  
**V-032-3413**  
 16 cm / 6¼"  
 Long  
 Plastic surgery, american  
 made retractor



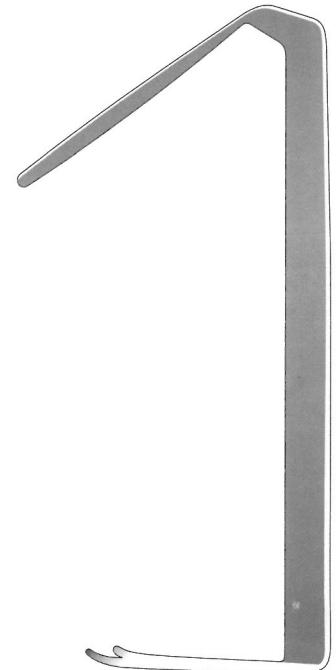
**Cottle**  
**V-032-1599**  
 15 cm / 6"



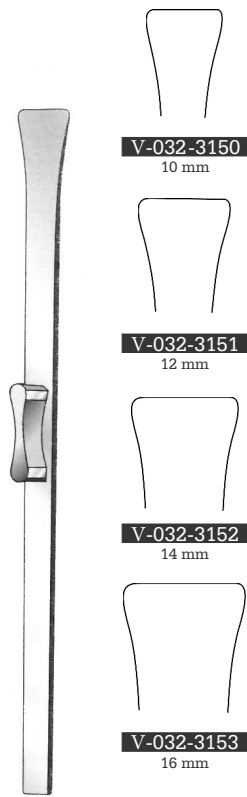
**Aufricht**  
**V-032-1601**  
 13.5 cm / 5¼"  
 60 x 6.5 mm blade  
 blunt



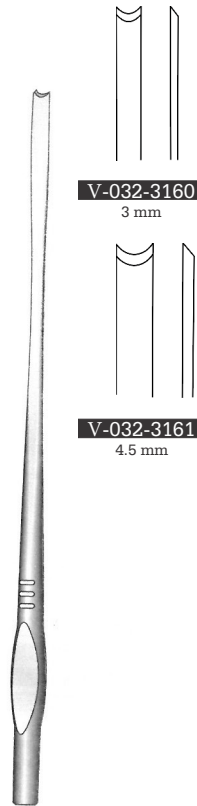
**Aufricht**  
**V-033-800** 19 cm / 7½"  
 40 x 12 mm blade  
**V-033-801** 16 cm / 6¼"  
 45 x 6 mm blade



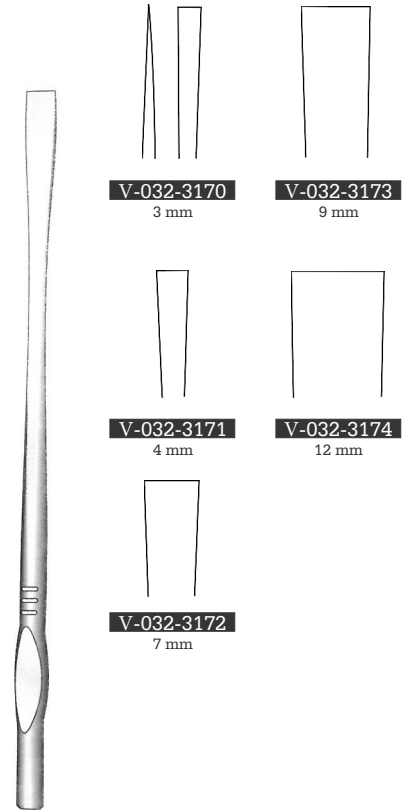
**Aufricht**  
**V-033-1390**  
 11 cm / 4¼"  
 50 x 6 mm



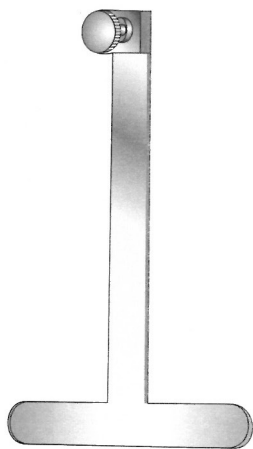
Rubin  
 18.5 cm / 7 1/4"  
 Osteotomes



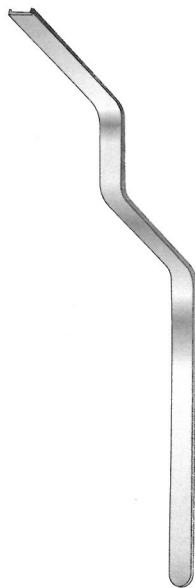
Walter  
 19 cm / 7 1/2"



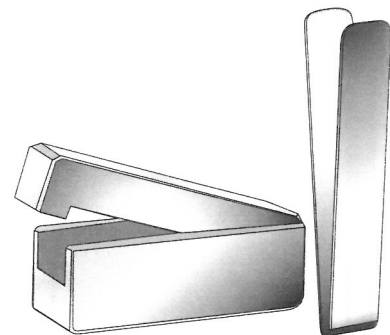
Walter  
 19 cm / 7 1/2"



Cottle  
**V-032-3180**  
 12 cm / 4 3/4"  
 Handle



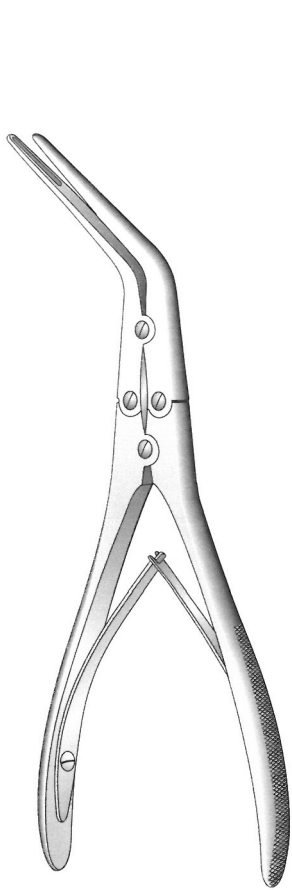
Cottle  
**V-032-3190**  
 7 mm width  
 Guide support for osteotomes



Cottle  
**V-032-3200**  
 65 x 30 x 30 mm  
 Cartilage crusher

# Rhinology

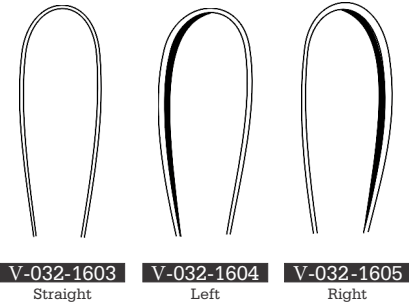
Septum Forceps, Septum Straightening Forceps, Skin Grasping Forceps  
 Septumzangen, Septumrichtzangen, Hautfasspinzetten  
 Pinzas para tabique nasal, Pinzas para enderezar el tabique nasal, Pinzas para piel



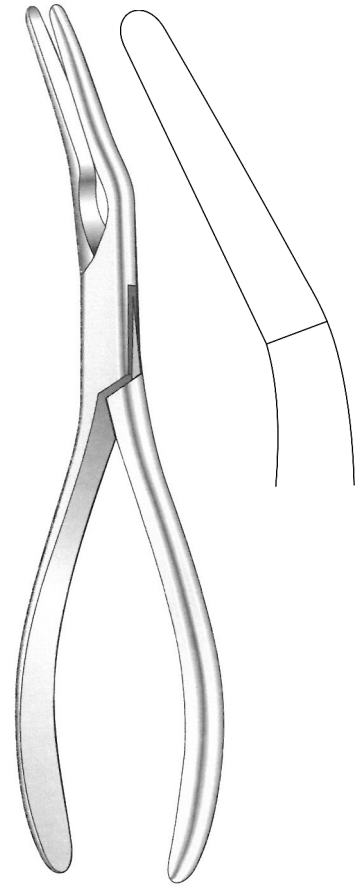
**Kressner**  
**V-032-1606**  
 20 cm / 8"



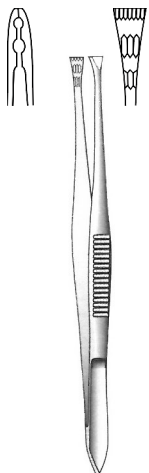
**Cottle-Walsham**  
 23 cm / 9"



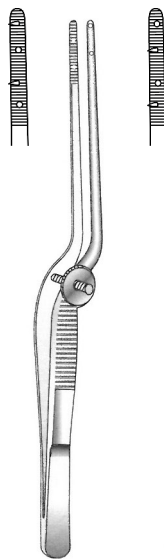
**V-032-1603** Straight  
**V-032-1604** Left  
**V-032-1605** Right



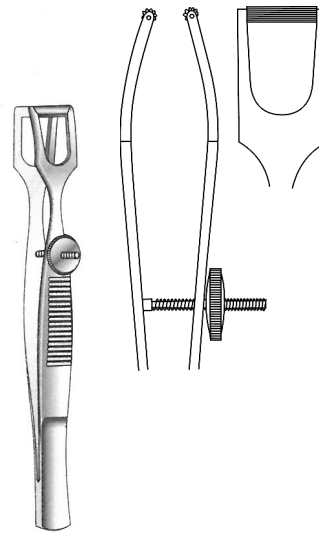
**Asch**  
**V-032-1602**  
 23 cm / 9"



**Ogura**  
**V-032-1607**  
 11 cm / 4 1/4"  
 4 mm wide



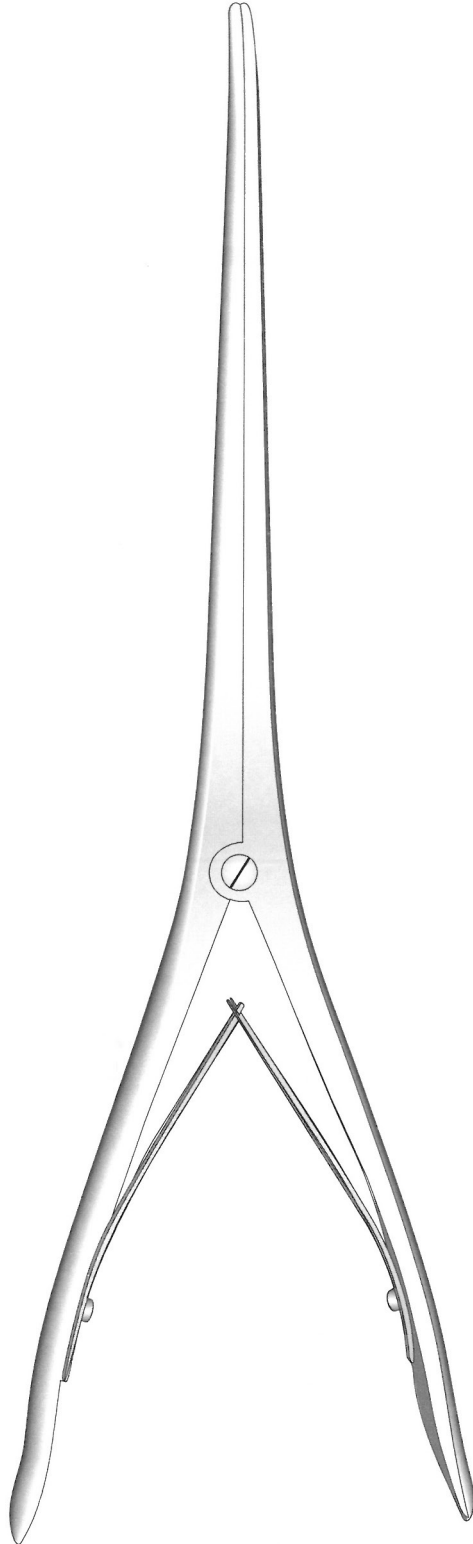
**Cottle**  
**V-032-1608**  
 14 cm / 5 1/2"  
 1.7 mm wide with teeth



**Cottle**  
**V-032-1609**  
 11 cm 4 1/4"  
 12 mm wide  
 Columella forceps



**Aiach**  
**V-032-1611**  
 15.5 cm / 6"  
 5 mm wide  
 Columella suturing forceps



### LaRoe Tissue Spreaders

**V-032-3420** Straight

**V-032-3421** Curved

23 cm / 9"

Small

**V-032-3425** Tapered, mod.

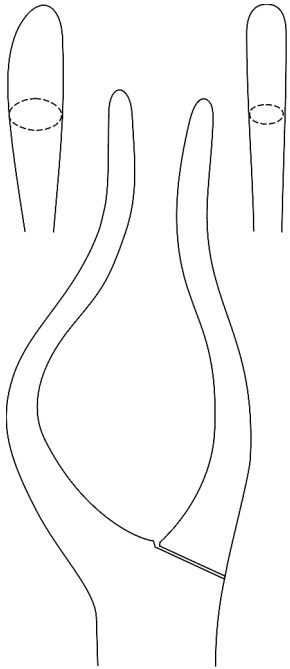
**V-032-3426** Curved

26 cm / 10¼"

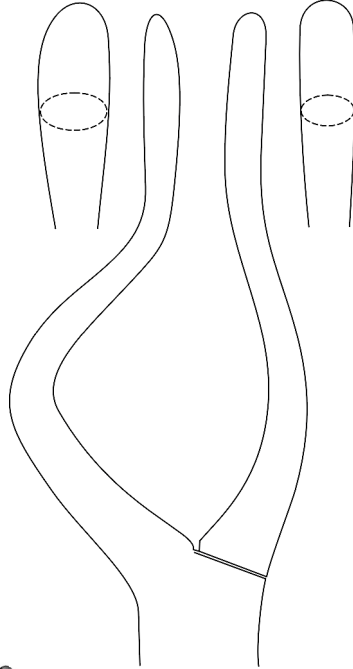
Large

# Rhinology

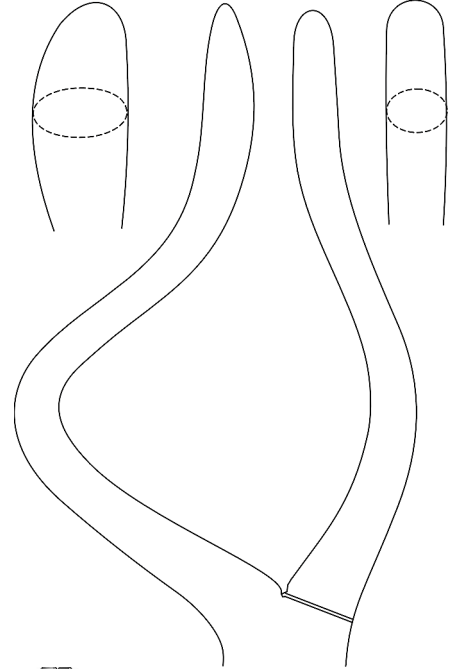
Disimpaction Forceps  
Repositionszangen  
Pinzas para reposicion



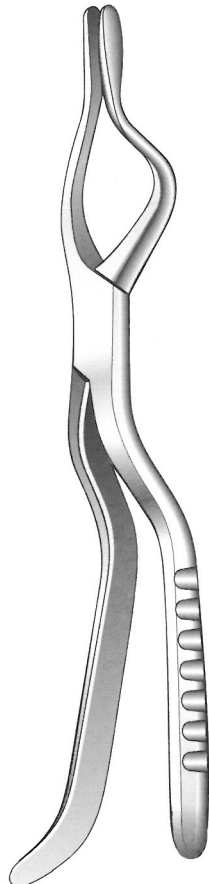
V-032-3210 Left  
V-032-3211 Right



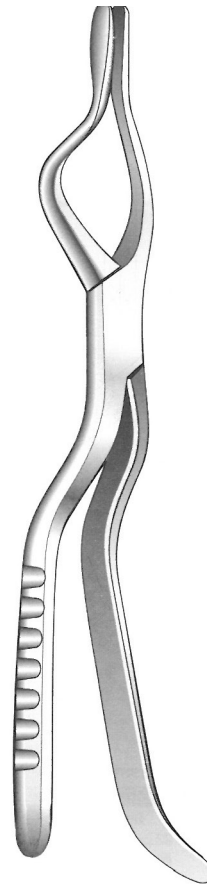
V-032-3220 Left  
V-032-3221 Right



V-032-3230 Left  
V-032-3231 Right

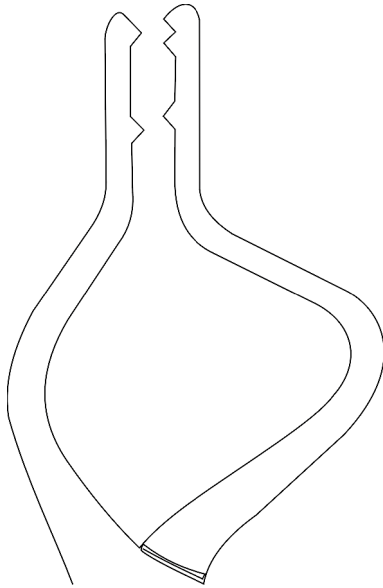


Rowe  
22.5 cm / 9"  
Left

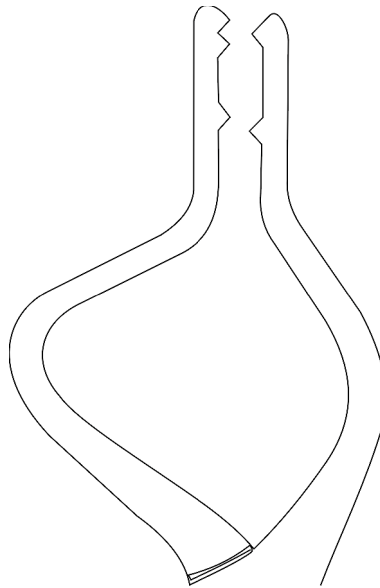


Rowe  
24 cm / 9½"  
Right

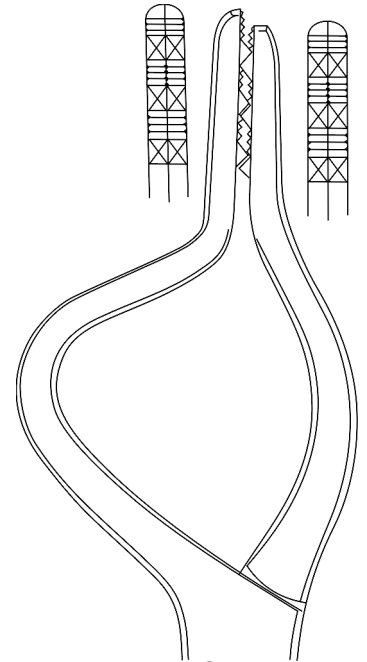




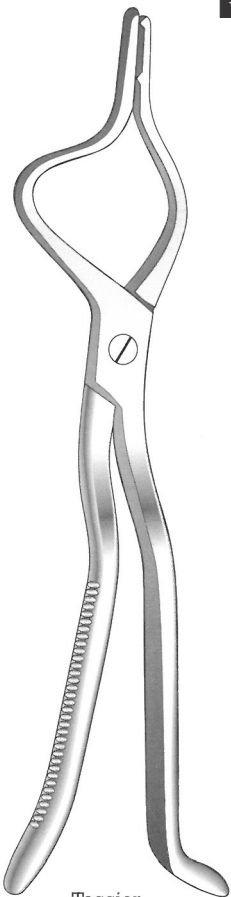
Tessier  
**V-032-3250**  
 Left  
 23 cm / 9"  
 For Adults



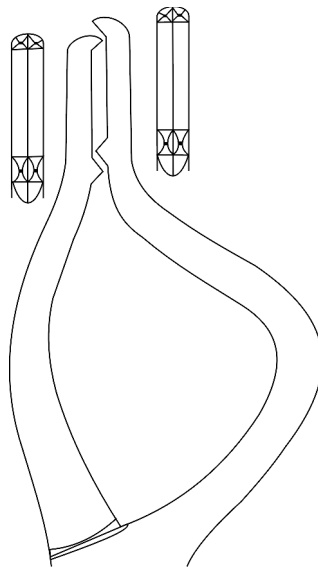
Tessier  
**V-032-3251**  
 Right  
 23 cm / 9"  
 For Adults



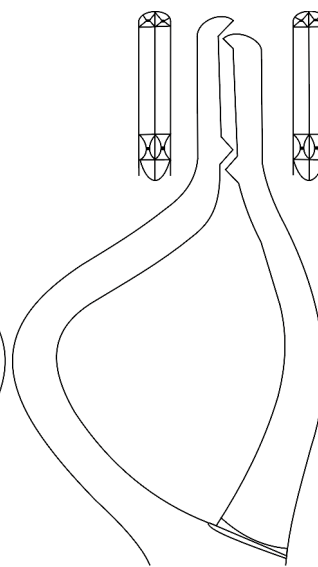
Marchac  
**V-032-3260**  
 23 cm / 9"  
 For children



Tessier  
 23 cm / 9"  
 For adults



Tessier  
**V-032-3240**  
 Left  
 22 cm / 8 1/4"  
 For children

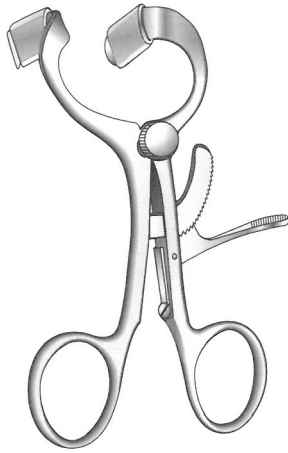


Tessier  
**V-032-3241**  
 Right  
 22 cm / 8 1/4"  
 For children

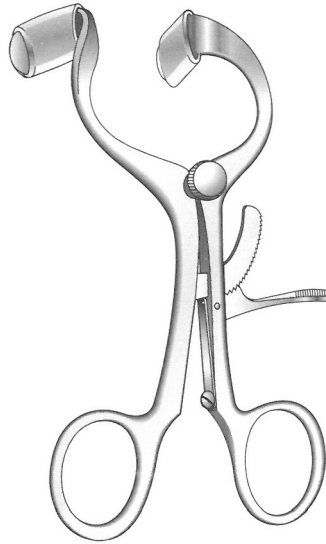


# Oral Instruments

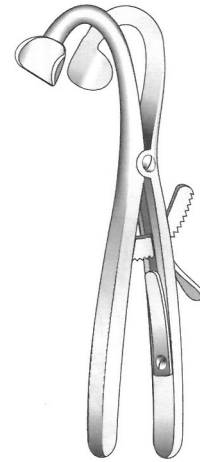
Mouth Gags  
Mundsperrer  
Abrebocas



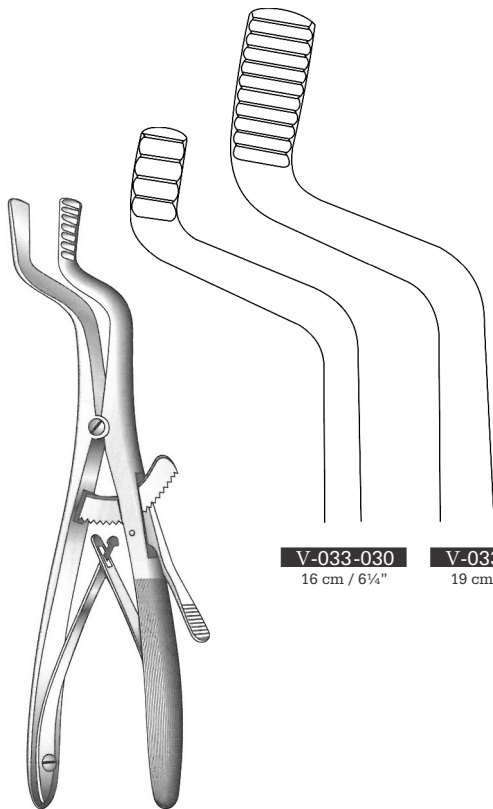
Molt / Doyen  
V-033-001  
11 cm / 4 1/4"



Molt / Doyen  
V-033-010  
14 cm / 5 1/2"



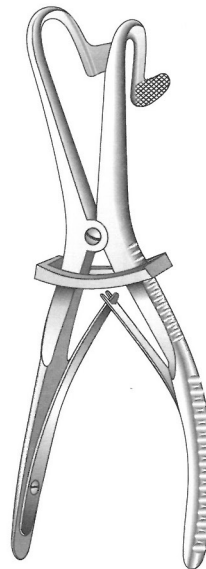
Denhart  
V-033-020  
12 cm / 4 3/4"  
16 mm jaw



V-033-030  
16 cm / 6 1/4"

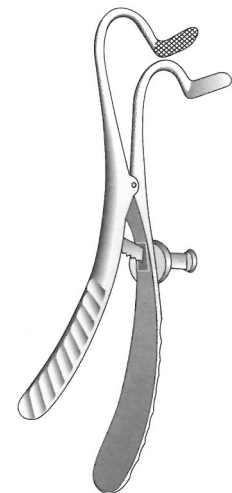
V-033-040  
19 cm / 7 1/2"

Roser-Konig



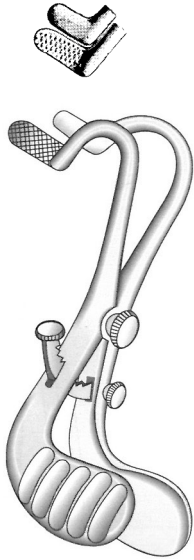
V-033-050 16 cm / 6 1/4"  
V-033-060 19 cm / 7 1/2"  
Ackland jaws

V-033-070  
V-033-080  
Parallel jaws



V-033-090 16 cm / 6 1/4"  
V-033-100 19 cm / 7 1/2"  
Ackland jaws

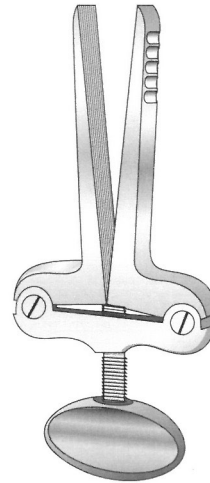
V-033-110  
V-033-120  
Parallel jaws



Buxton

V-033-130 Ackland jaws

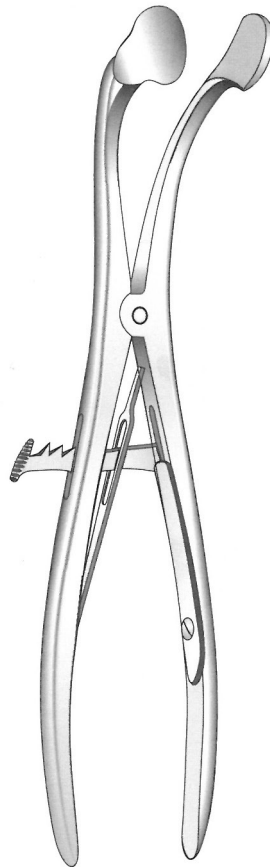
V-033-140 Parallel jaws



Heister

V-033150

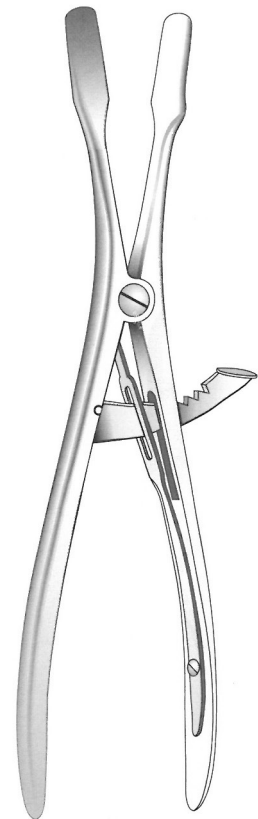
13 cm / 5"



Delabarre

V-033-045

20 cm / 8"



Terrier

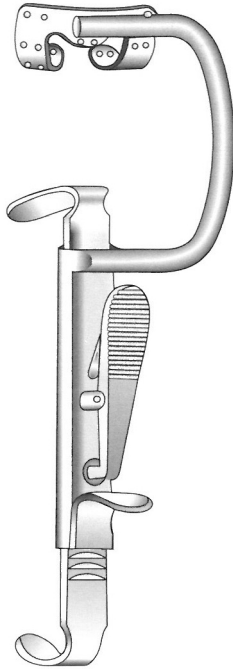
V-033-041 Straight

V-033-042 Curved

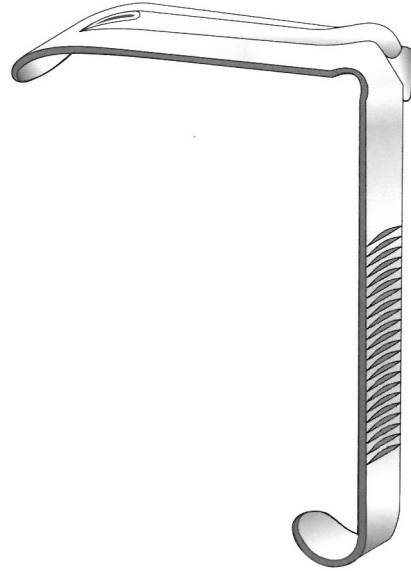
20 cm / 8"

# Oral Instruments

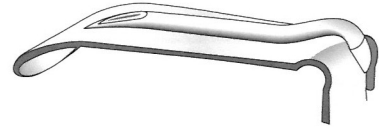
Mouth Gags  
Mundsperrer  
Abrebocas



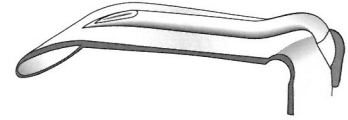
**V-033-159**  
Frame only



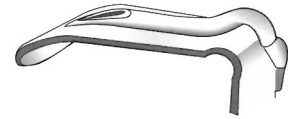
**V-033-160**  
27 x 105 mm



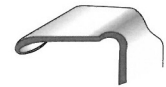
**V-033-170**  
25 x 90 mm



**V-033-180**  
25 x 75 mm



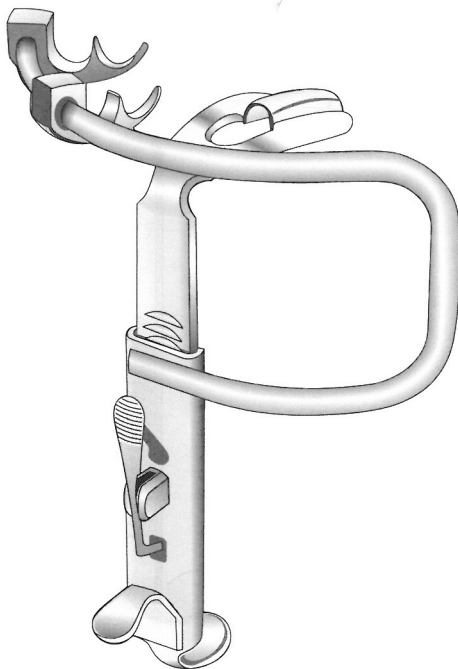
**V-033-190**  
22 x 60 mm



**V-033-191**  
20 x 25 mm

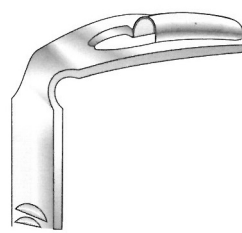
**Davis Boyle**  
**V-033-181**

Complete set with frame & 5 blades

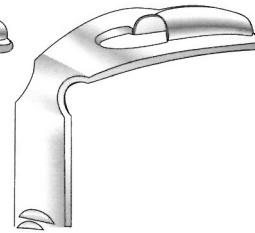


**Kilner Doughty**  
**V-033-185**

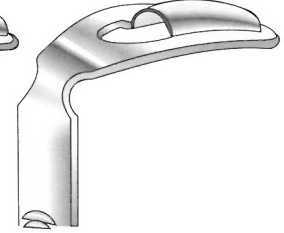
Complete with frame, 3 tongue depressors,  
2 tooth plates and 1 palate plate



**V-033-186**  
13.5 cm / 5 1/4"  
70 x 29 mm



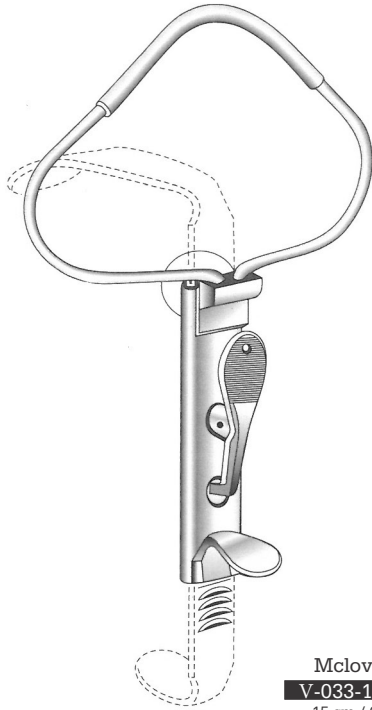
**V-033-187**  
13.5 cm / 5 1/4"  
80 x 34 mm



**V-033-188**  
13.5 cm / 5 1/4"  
85 x 38 mm

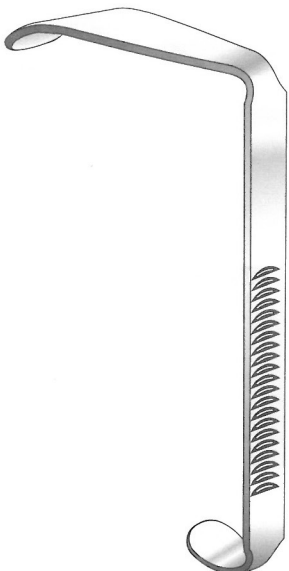


**V-033-189**  
14.5 cm / 5 3/4"  
Frame only for mouth gag

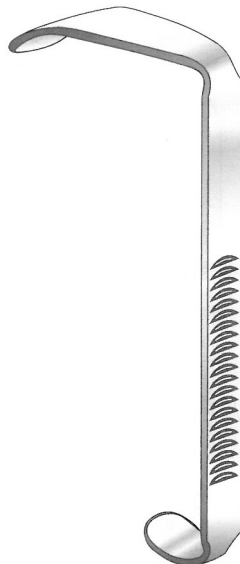


Mclovr  
**V-033-196**  
15 cm / 6"  
65 x 100 mm  
Frame for mouth gag

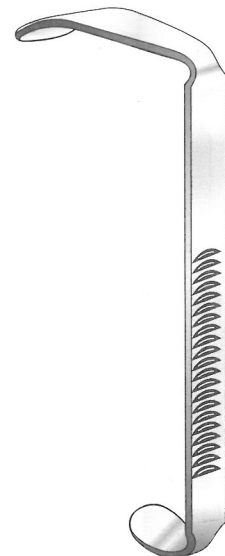
**V-033-195**  
Complete with frame  
and 3 tongue blades



Mclovr  
**V-033-197**  
13.5 cm / 5¼"  
100 x 26 mm  
Tongue depressor



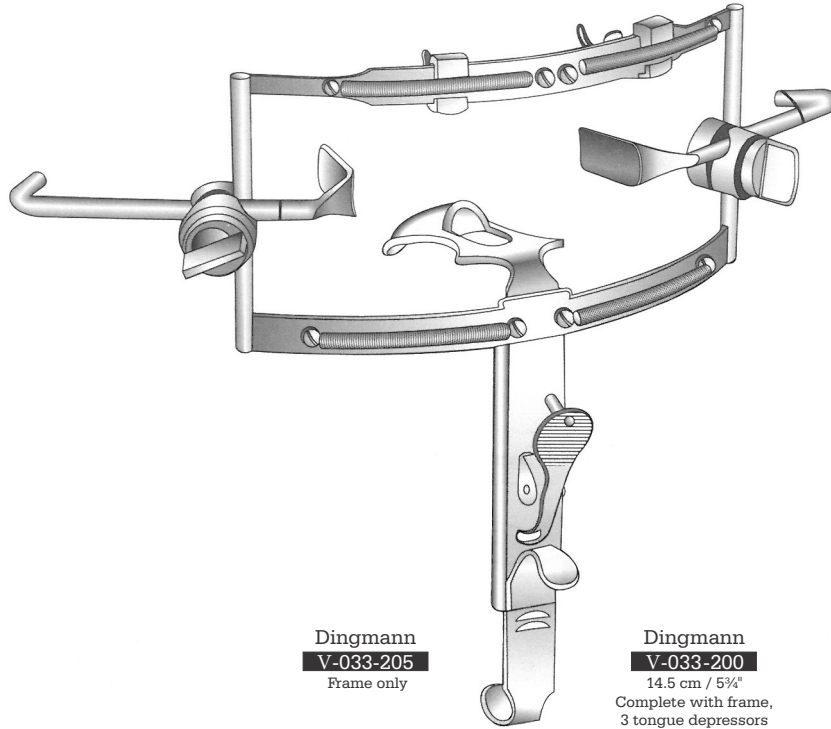
Mclovr  
**V-033-198**  
13.5 cm / 5¼"  
85 x 25 mm  
Tongue depressor



Mclovr  
**V-033-199**  
13.5 cm / 5¼"  
75 x 23 mm  
Tongue depressor

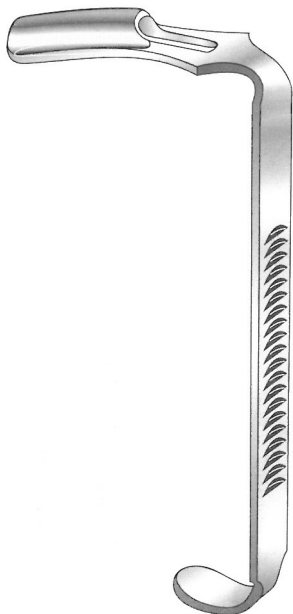
# Oral Instruments

Mouth Gags  
Mundsperrer  
Abreboocas

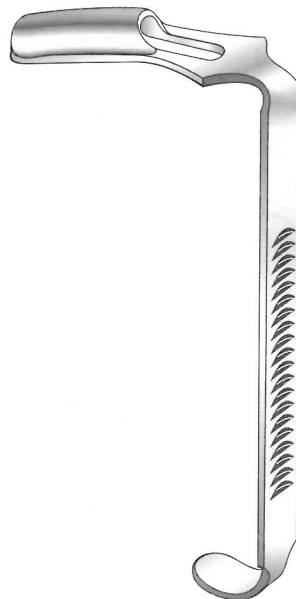


Dingmann  
**V-033-205**  
Frame only

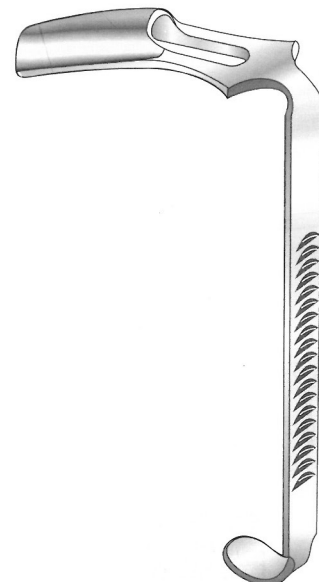
Dingmann  
**V-033-200**  
14.5 cm / 5 3/4"  
Complete with frame,  
3 tongue depressors  
and 2 adjustable lateral blades



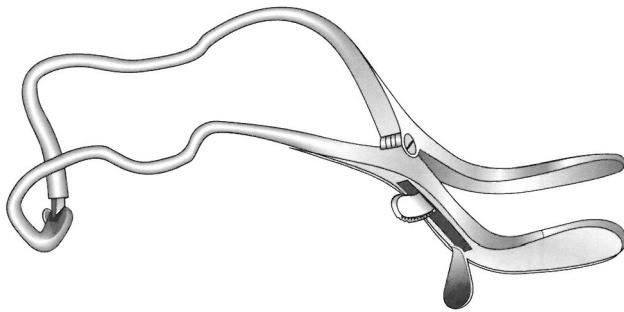
Dingmann  
**V-033-201**  
13.5 cm / 5 1/4"  
65 x 25 mm  
Tongue depressor



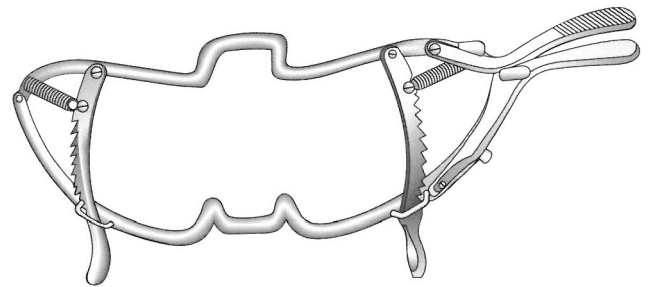
Dingmann  
**V-033-202**  
13.5 cm / 5 1/4"  
70 x 29 mm  
Tongue depressor



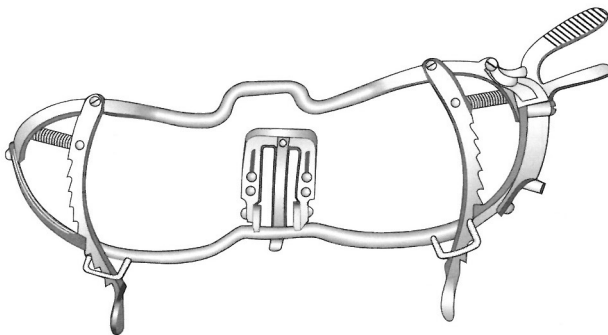
Dingmann  
**V-033-203**  
13.5 cm / 5 1/4"  
80 x 32 mm  
Tongue depressor



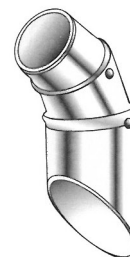
**Jenning**  
**V-033-280** 9 cm / 3½"  
**V-033-290** 11 cm / 4¼"  
**V-033-300** 13 cm / 5"  
**V-033-310** 15 cm / 6"



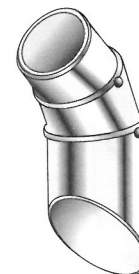
**Whitehead**  
**V-033-220** 11 cm / 4¼"  
**V-033-230** 13 cm / 5"  
**V-033-240** 15 cm / 6"



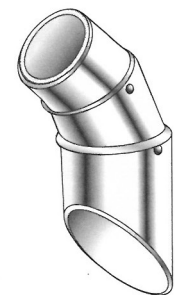
**Whitehead**  
**V-033-250** 11 cm / 4¼"  
**V-033-260** 13 cm / 5"  
**V-033-270** 15 cm / 6"



**Langenbeck**  
**V-033-320**



**Langenbeck**  
**V-033-330**



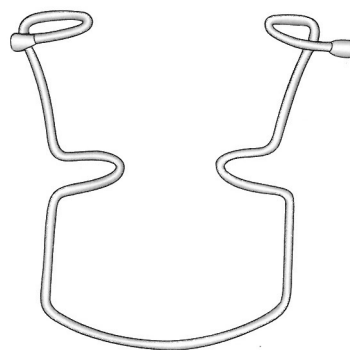
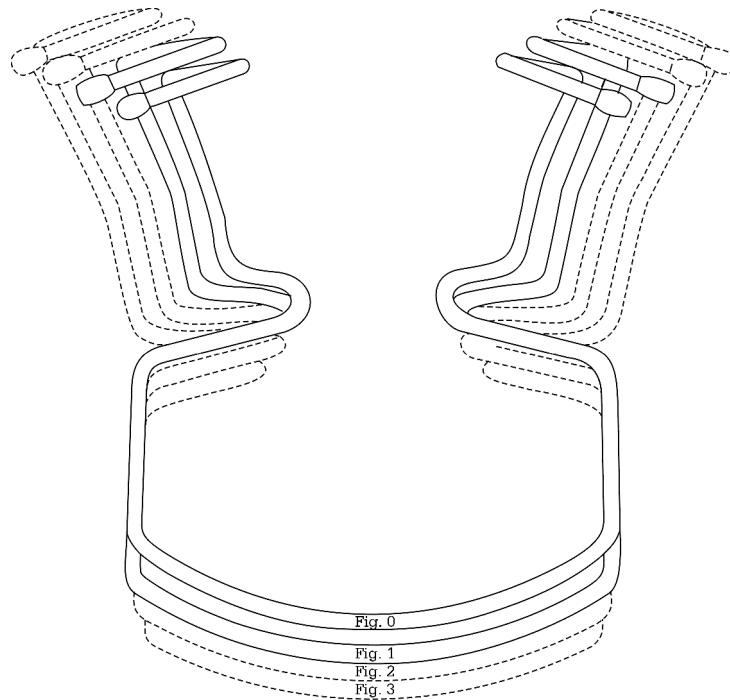
**Langenbeck**  
**V-033-340**

## Oral Instruments

Lip and Cheek Retractors

Lippen- u. Wangenhalter

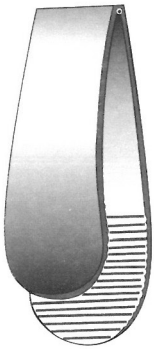
Separadores para labios Y mejillas



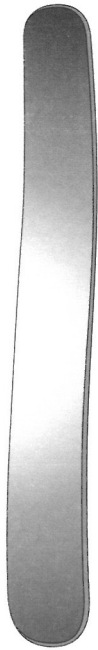
**Oringer**  
Self retaining

<b>V-033-345</b>	9.5 cm / 3¾"	95 mm, Fig. 0
<b>V-033-346</b>	10 cm / 4"	110 mm, Fig. 1
<b>V-033-347</b>	10.5 cm / 4"	115 mm, Fig. 2
<b>V-033-348</b>	11 cm / 4¼"	120 mm, Fig. 3
<b>V-033-349</b>	Set of 4, Fig.0 -Fig.3	

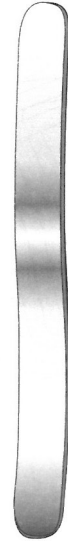




**Tobold**  
**V-033-350**  
12 cm / 4¾"



**Mayo**  
**V-033-360**  
17 cm / 6¾"



**V-033-370**  
14 cm / 5½"



**V-033-380**  
14 cm / 5½"

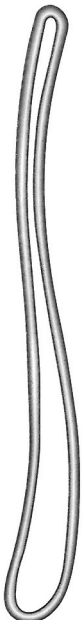


**Doyen**  
**V-033-390**  
13 cm / 5"  
24/30 mm

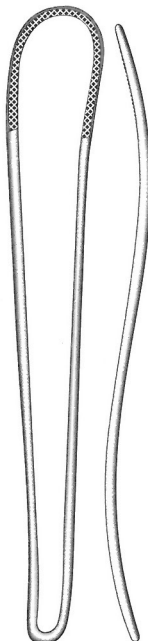
**V-033-400**  
16 cm / 6¼"  
30/34 mm



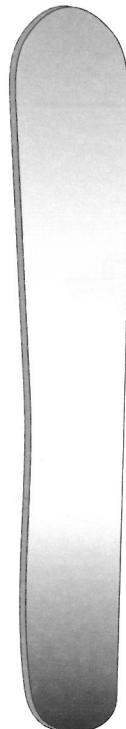
**Bruenings**  
**V-033-410**  
19 cm / 7½"  
19/15 mm



**Collin**  
**V-033-420**  
16.5 cm / 6½"



**Frenzel**  
**V-033-430**  
16.5 cm / 6½"



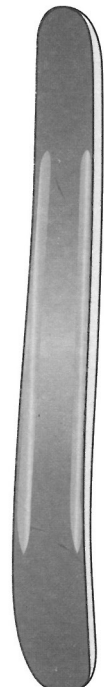
**Buchwald**  
**V-033-440**  
17 cm / 6¾"



**V-033-442**  
16 cm / 6¼"  
Wood  
Package of  
100 Pieces



**V-033-444**  
15 cm / 6"  
Acrylic glass  
Package of  
100 Pieces



**V-033-446**  
18.5 cm / 7¼"  
Nylon  
Package of  
100 Pieces

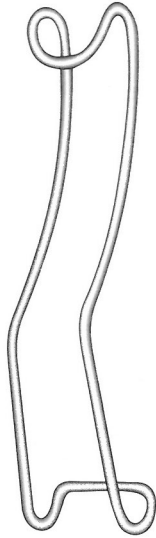
## Oral Instruments

Lip and Cheek Retractors

Lippen- u. Wangenhalter

Separadores para labios y mejillas

# VOLMED

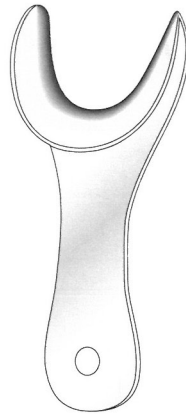


Sternberg

V-033-491 12 cm / 4¾"

V-033-492 14 cm / 5½"

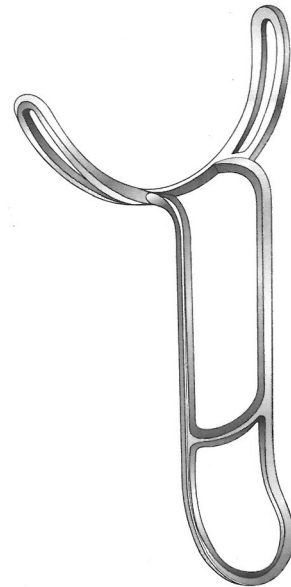
V-033-493 16 cm / 6¼"



Simplex

V-033-600

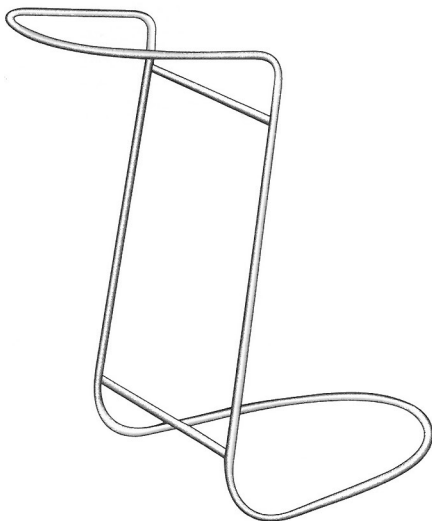
10.5 cm / 4"



V-033-610

14 cm / 5½"

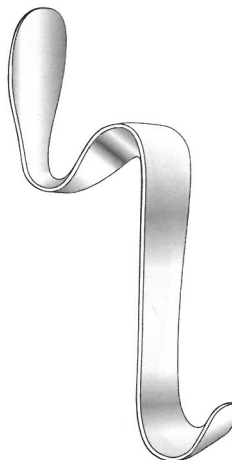
Vestibulum retractor



Obwegeser

V-033-620

12 cm / 4¾"

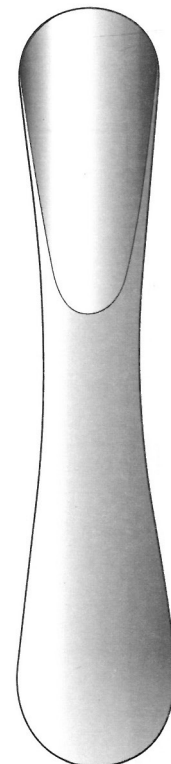


Bishop

V-033-494

13.5 cm / 5¼"

27 mm



Jaeger

V-033-1380

Stainless steel

V-033-1381

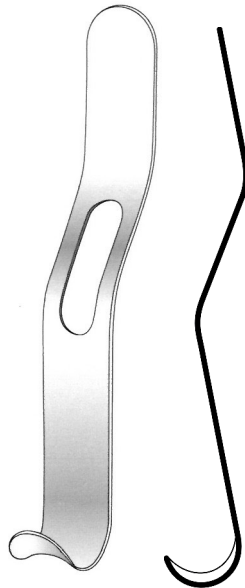
Plastic

10 cm / 4"

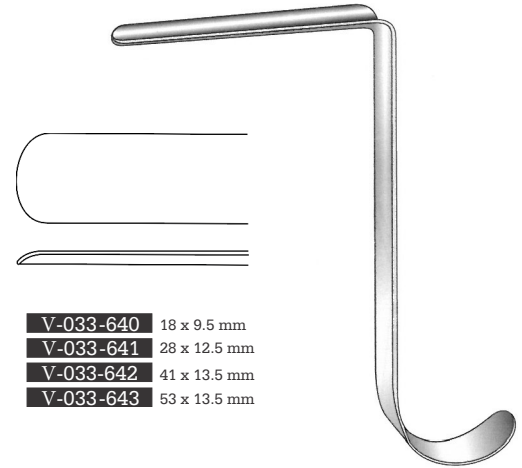
Lid plate



Crawford Minnesota  
**V-033-495**  
 15 cm / 6"  
 20 mm



**V-033-630**  
 14.5 cm / 5 3/4"  
 Fenestrated

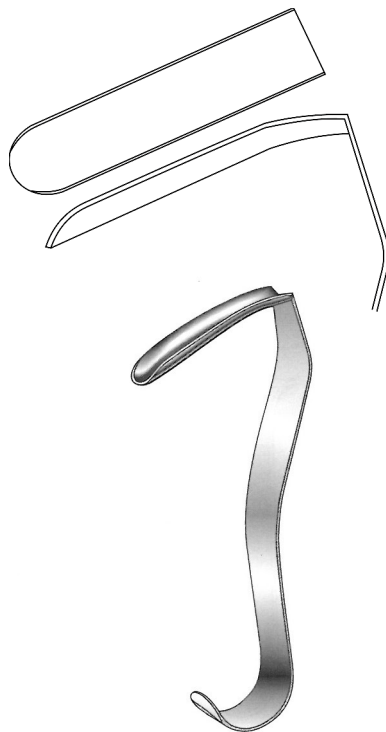


**V-033-640** 18 x 9.5 mm  
**V-033-641** 28 x 12.5 mm  
**V-033-642** 41 x 13.5 mm  
**V-033-643** 53 x 13.5 mm

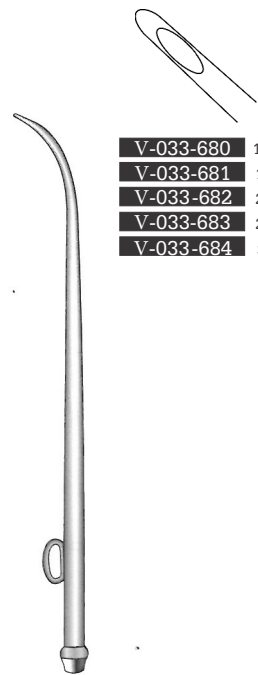
Converse  
 9 cm / 3 1/2"



Lange  
**V-033-670**  
 23 cm / 9"  
 Alar hooklet, button end



Converse  
**V-033-650**  
 10.5 cm / 4"  
 44 x 11 mm blade



**V-033-680** 1.5 mm Ø  
**V-033-681** 1.7 mm Ø  
**V-033-682** 2.0 mm Ø  
**V-033-683** 2.5 mm Ø  
**V-033-684** 3.0 mm Ø

Siebenmann  
 15 cm / 6"  
 Antrum cannula

# Oral Instruments

Tongue Depressors

Zungendrucker

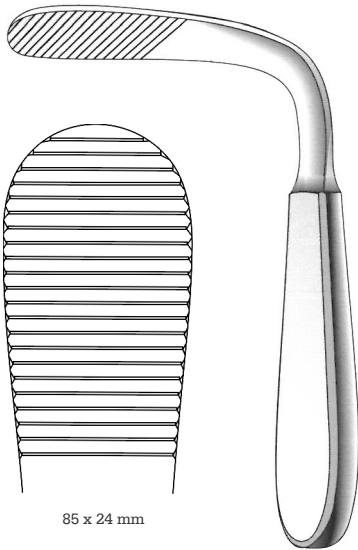
Abajalenguas



Bosworth

V-033-450

14 cm / 5½"

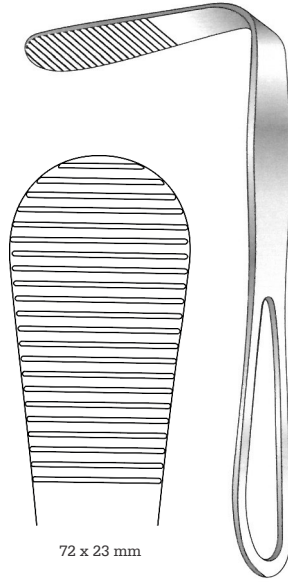


85 x 24 mm

Tobold

V-033-460

14 cm / 5½"

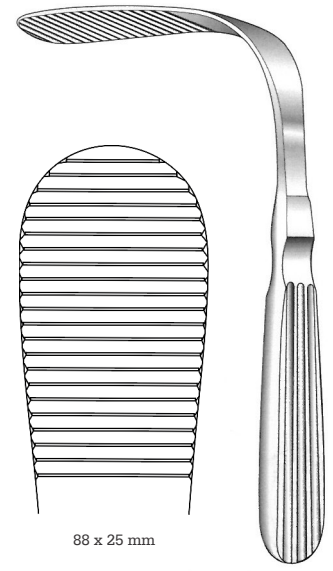


72 x 23 mm

Hartmann

V-033-462

15 cm / 6"

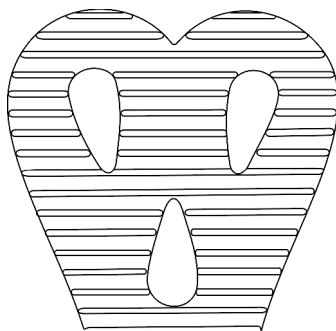


88 x 25 mm

Tobold

V-033-464

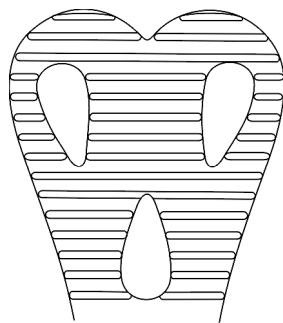
15 cm / 6"



V-033-480

15 cm / 6"

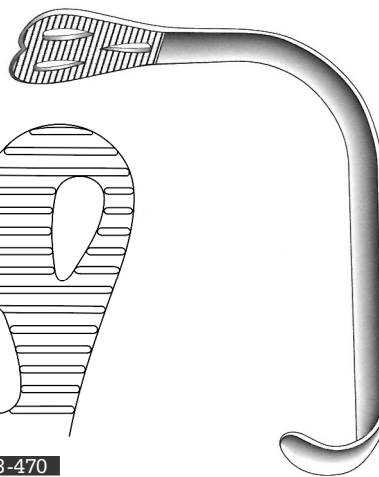
43 mm



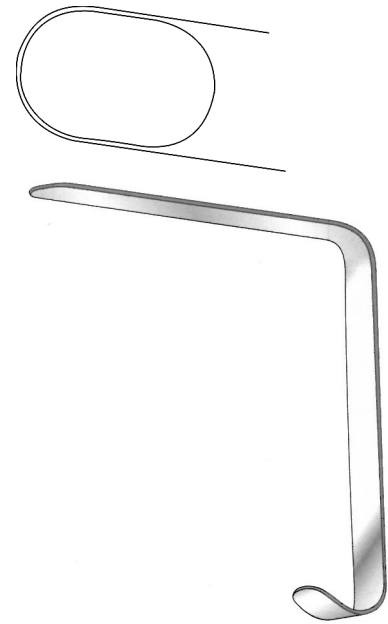
V-033-470

14 cm / 5½"

36 mm



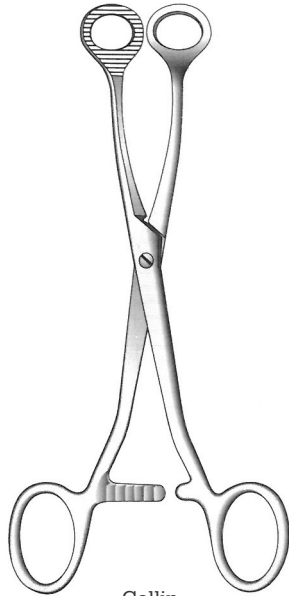
Wieder



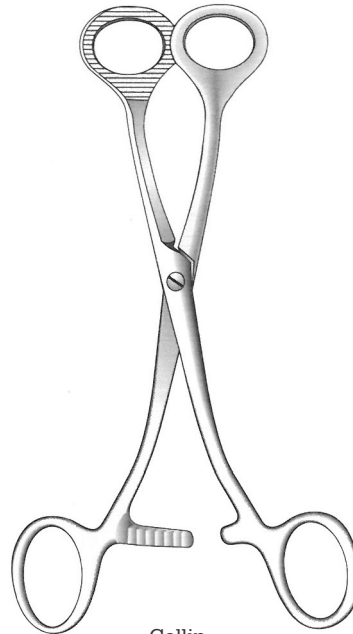
Lack

V-033-490

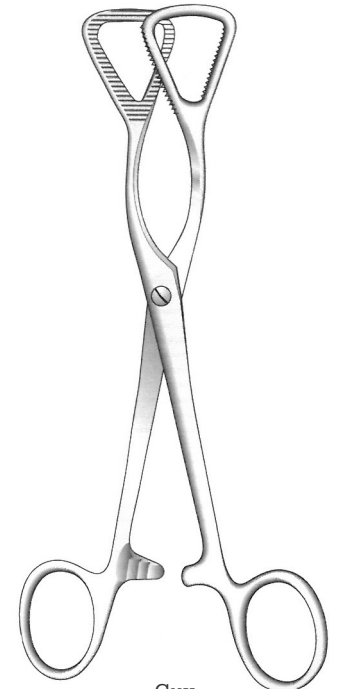
10 cm / 4"



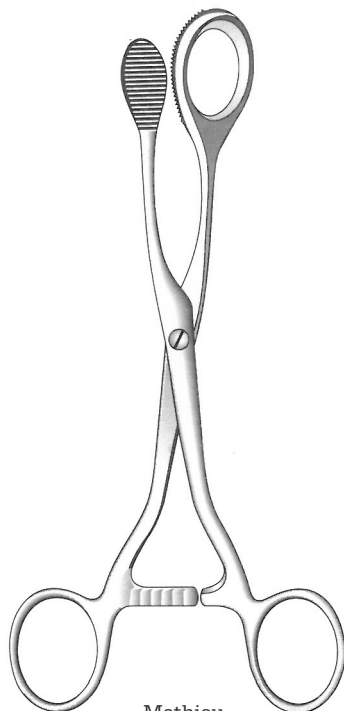
Collin  
V-033-500  
16 cm / 6¼"



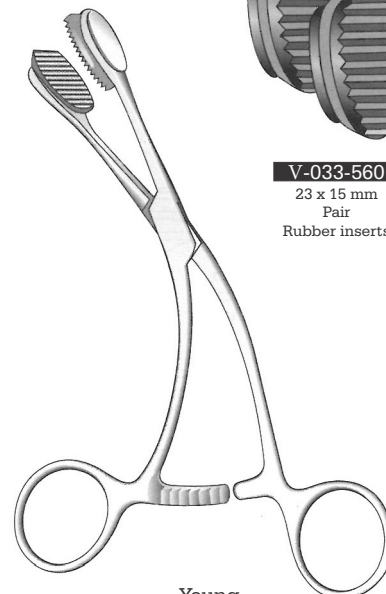
Collin  
V-033-509 16 cm / 6¼"  
V-033-510 17 cm / 6¾"  
V-033-520 19 cm / 7½"



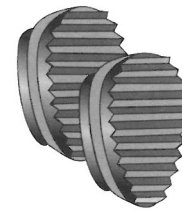
Guy  
V-033-530  
19 cm / 7½"



Mathieu  
V-033-540  
19 cm / 7½"



Young  
V-033-550  
17 cm / 6¾"



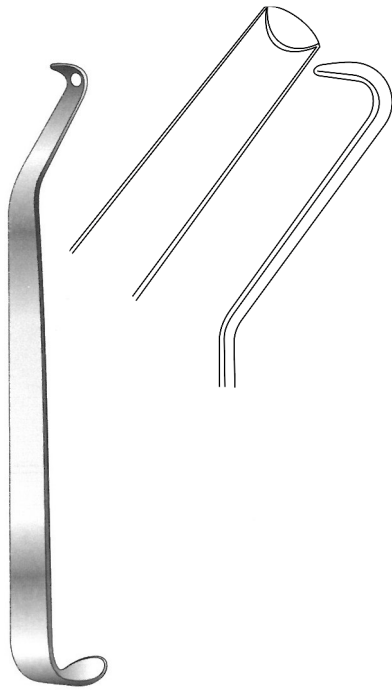
V-033-560  
23 x 15 mm  
Pair  
Rubber inserts

# Oral Instruments

Chin, Channel & Ramus Retractors

Kinnhalter, Progenierinnen und Ramushaken

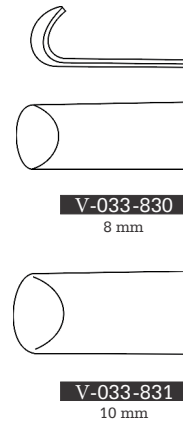
Gancho de menton, Separadores mandibulares Y de Rama



Terry  
**V-033-810**  
 16.5 cm / 6½"

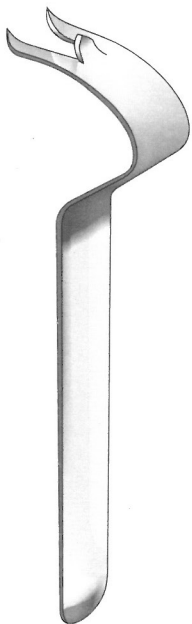


Obwegeser  
**V-033-820** 8 mm  
**V-033-821** 10 mm  
 17 cm / 6¾"

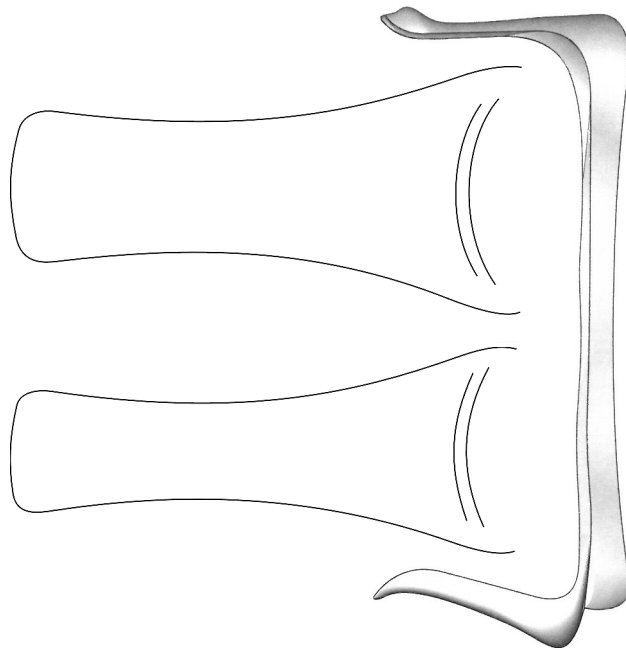


**V-033-830**  
 8 mm

**V-033-831**  
 10 mm



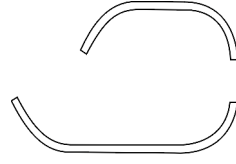
Obwegeser  
**V-033-840**  
 16.5 cm / 6½"



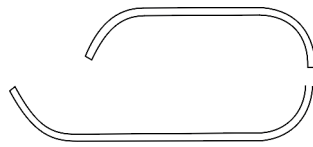
Hargis  
**V-033-850**  
 16 cm / 6¼"  
 Lip and cheek retractors



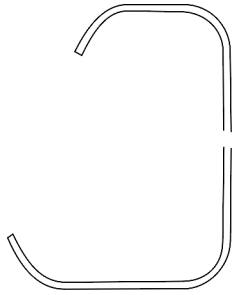
Obwegeser  
**V-033-700**  
 16 cm / 6¼"  
 16.5 mm  
 Chin holder



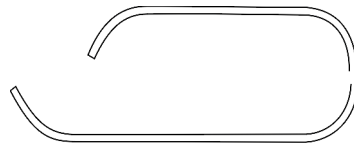
**V-033-870**  
20 x 12; 30 x 16 mm



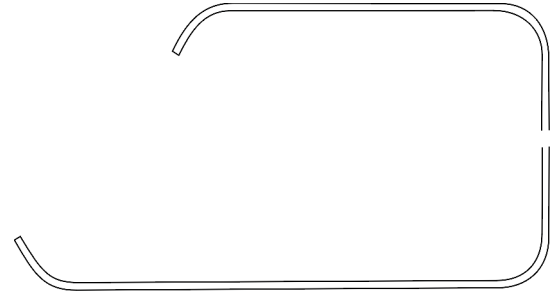
**V-033-872**  
30 x 12; 35 x 16 mm



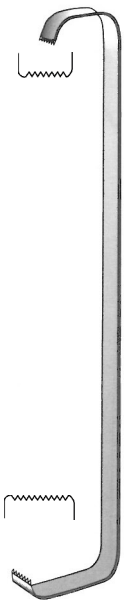
**V-033-860**  
20 x 7; 30 x 10 mm



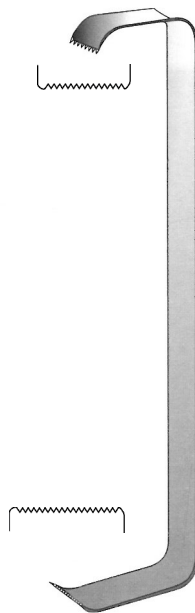
**V-033-874**  
35 x 12; 45 x 16 mm



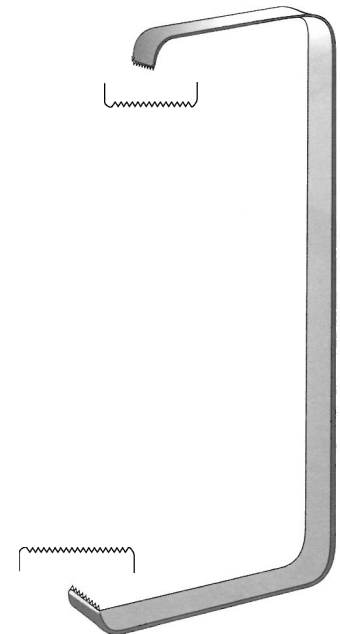
**V-033-880**  
50 x 12; 70 x 16 mm



**Tessier**  
15 cm / 6"  
Black chromium plated



**Tessier**  
15.5 cm / 6"  
Black chromium plated



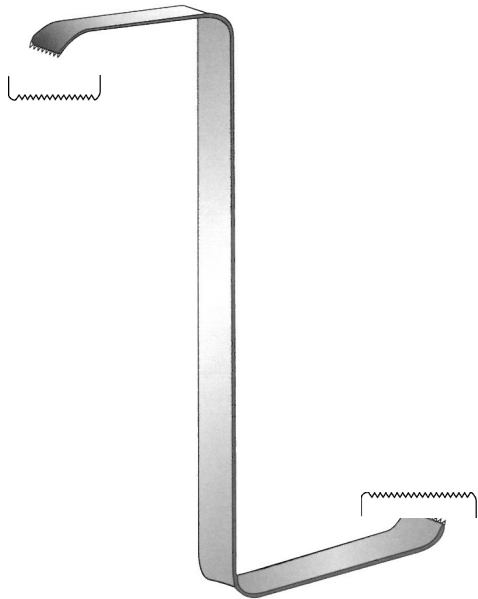
**Tessier**  
15.5 cm / 6"  
Black chromium plated

# Oral Maxillo-Facial Surgery

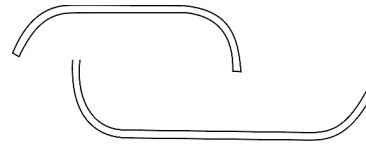
Soft Tissue Retractors

Weichteilhaken

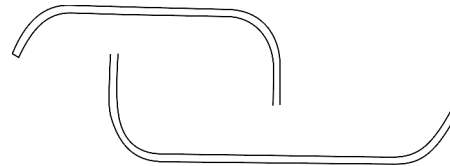
Separadores para partes blandas



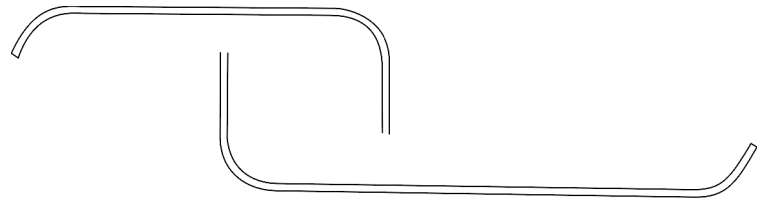
**Tessier**  
16 cm / 6¼"  
Black chromium plated



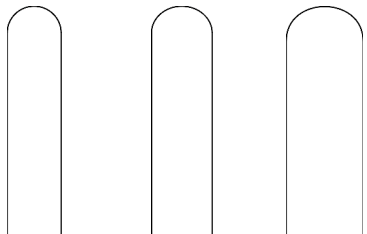
**V-033-890**  
30 x 12; 35 x 16 mm



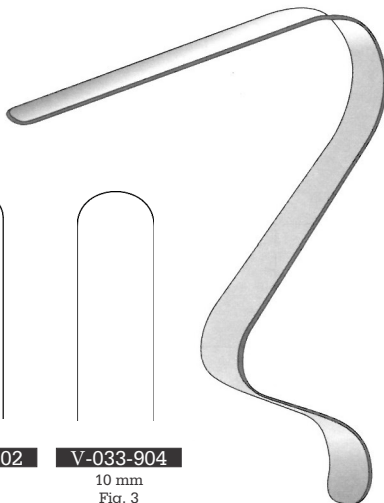
**V-033-892**  
35 x 12; 45 x 16 mm



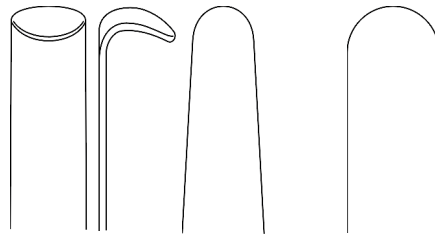
**V-033-894**  
50 x 12; 70 x 16 mm



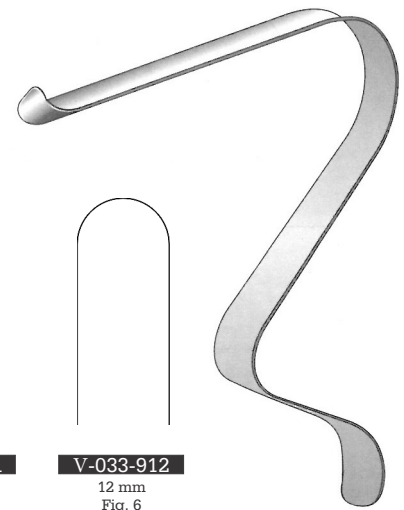
**V-033-900** 7 mm Fig. 1  
**V-033-902** 8 mm Fig. 2  
**V-033-904** 10 mm Fig. 3



**Tessier**  
12.5 cm / 5"  
Black chromium plated



**V-033-910** 10 mm Fig. 4  
**V-033-911** 8 mm Fig. 5  
**V-033-912** 12 mm Fig. 6

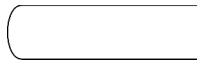


**Tessier**  
12.5 cm / 5"  
Black chromium plated





**V-033-920**  
5 x 16 mm



**V-033-921**  
7 x 25 mm



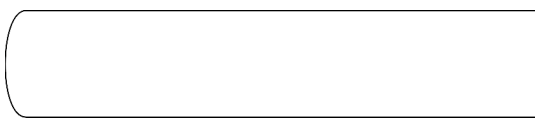
**V-033-922**  
10 x 35 mm



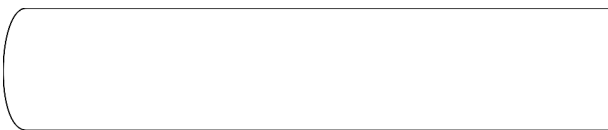
**V-033-923**  
10 x 42 mm



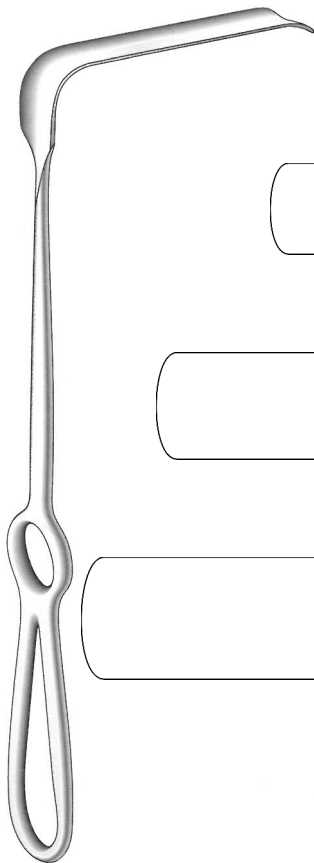
**V-033-924**  
12 x 55 mm



**V-033-925**  
14 x 70 mm



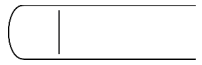
**V-033-926**  
16 x 80 mm



Obwegeser  
24 cm / 9½"  
Bent downwards



**V-033-95**  
5 x 16 mm



**V-033-95**  
7 x 25 mm



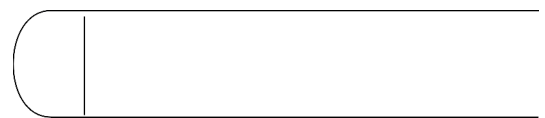
**V-033-95**  
10 x 35 mm



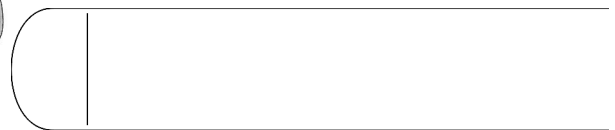
**V-033-95**  
10 x 42 mm



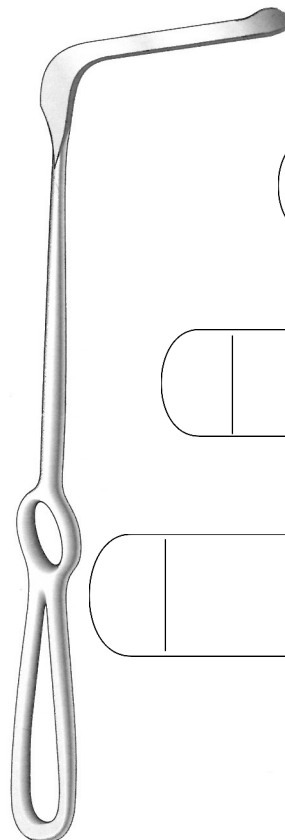
**V-033-95**  
12 x 55 mm



**V-033-95**  
14 x 70 mm



**V-033-95**  
16 x 80 mm



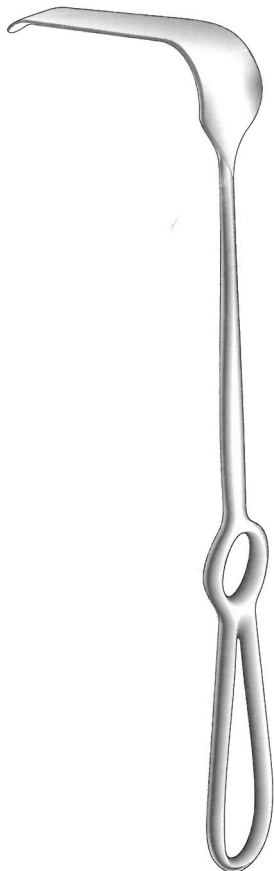
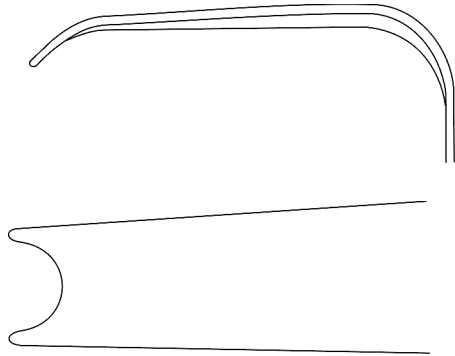
Obwegeser  
24 cm / 9½"  
Bent upwards

# Crano Maxillo-Facial Surgery

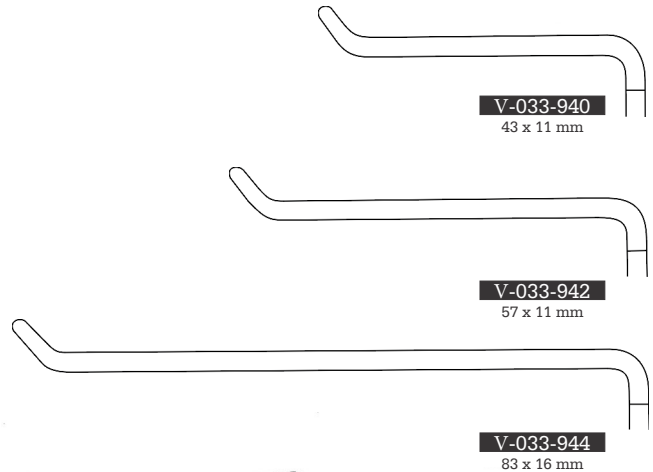
Third Molar and Soft Tissue Retractors

Weisheitszahn Haken und Weichteilhaken

Separador para muela del juicio Y para partes blandas



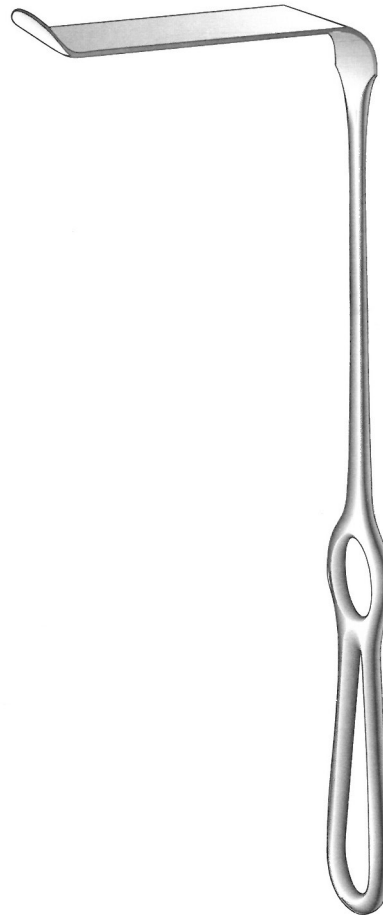
Obwegeser  
**V-033-930**  
15/22 x 70 mm  
24 cm / 9½"  
Third molar retractor



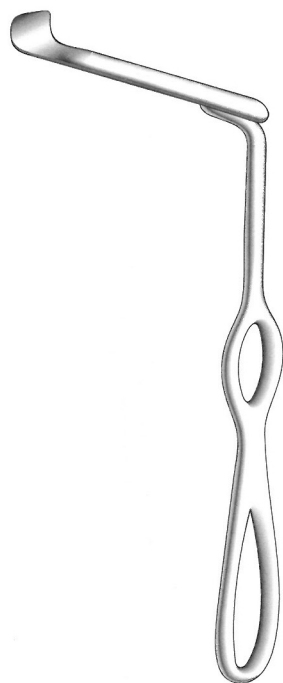
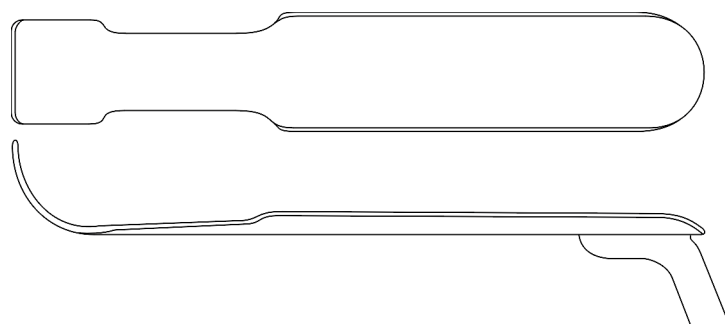
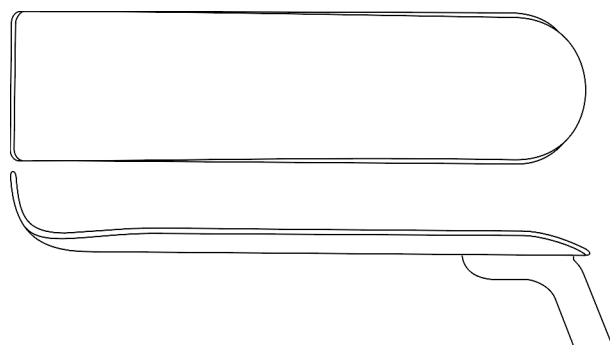
**V-033-940**  
43 x 11 mm

**V-033-942**  
57 x 11 mm

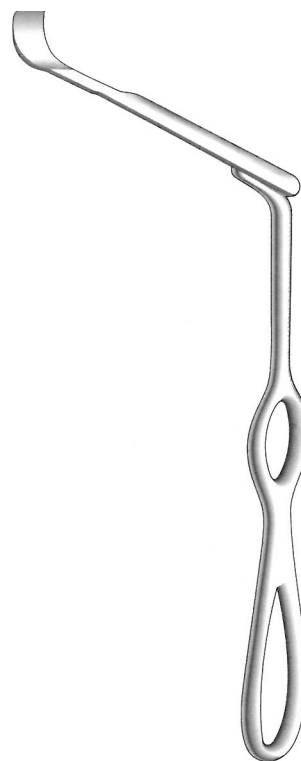
**V-033-944**  
83 x 16 mm



Obwegeser  
21.5 cm / 8½"



Schuchardt  
V-033-960  
15 cm / 6"



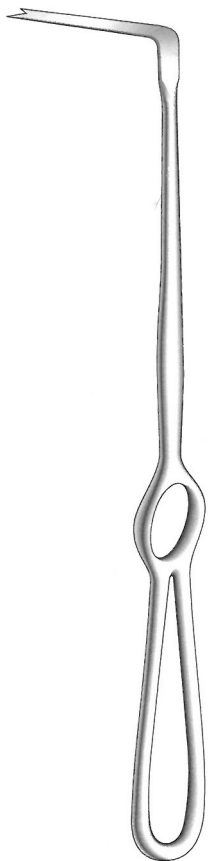
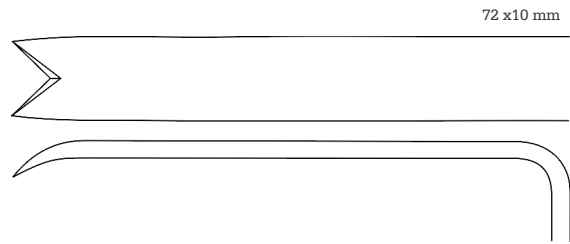
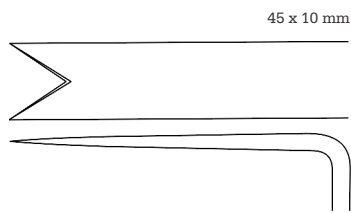
Metz  
V-033-970  
15 cm / 6"

# Oral Maxillo-Facial Surgery

Ramus Retractors

Ramushaken

Separadores para el ramo

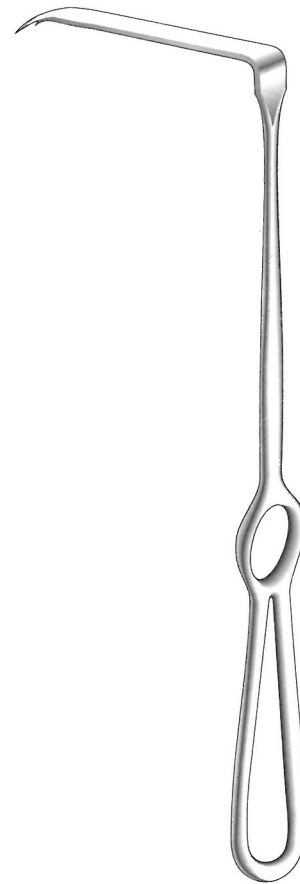


Obwegesser

V-033-980

22 cm / 8 3/4"

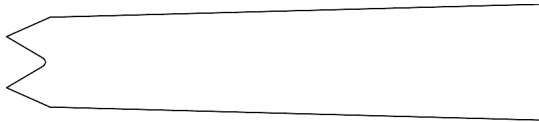
Nasal spine retractor



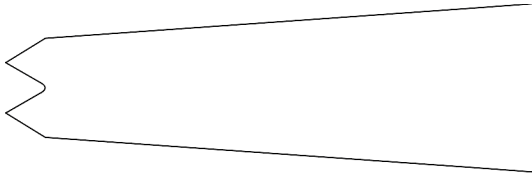
Obwegesser

V-033-990

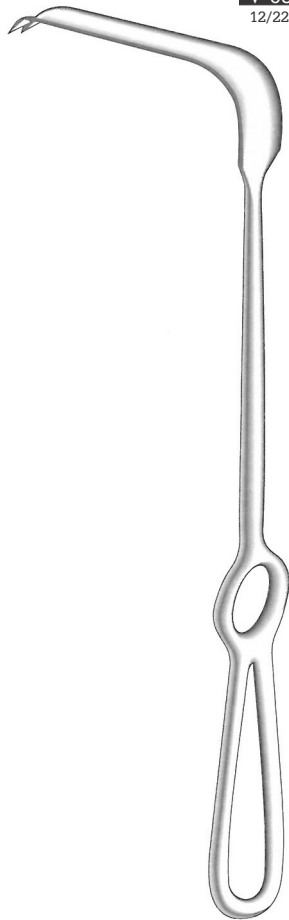
22 cm / 8 3/4"



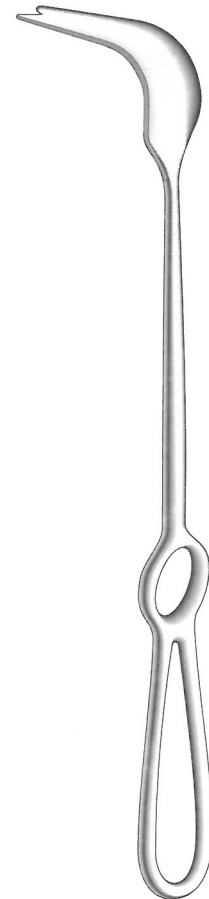
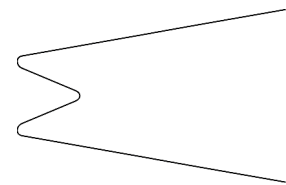
**V-033-1000**  
11/15 x 70 mm



**V-033-1002**  
12/22 x 70 mm



Obwegeser  
24.5 cm / 9 3/4"



Obwegeser  
**V-033-1010**  
24.5 cm / 9 3/4"  
10/23 x 40 mm  
Nasal spine retractor



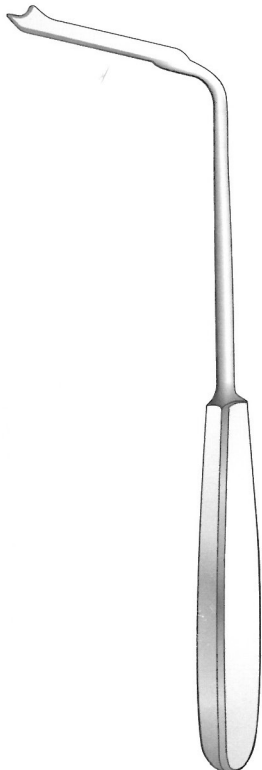
**V-033-1020**  
9/12 x 30 mm



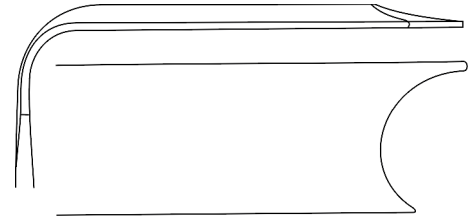
**V-033-1022**  
9/12 x 45 mm



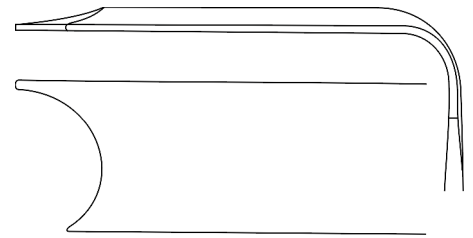
**V-033-1024**  
9/12 x 60 mm



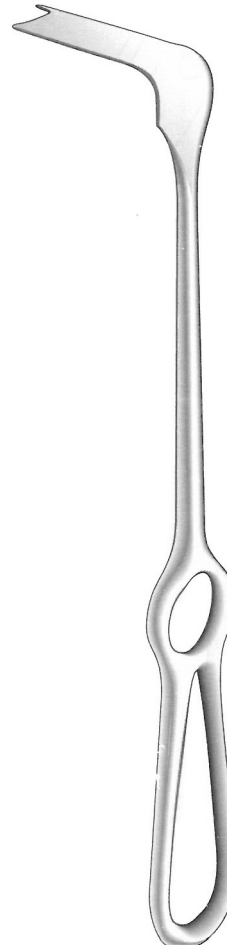
**Obwegeser**  
21 cm / 8¼"



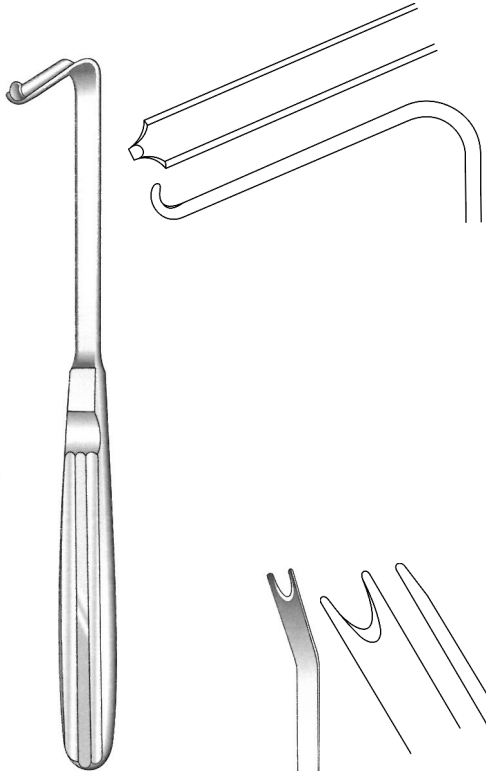
**V-033-1030**  
Left



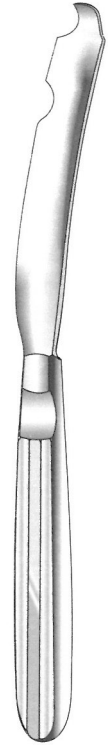
**V-033-1032**  
Right



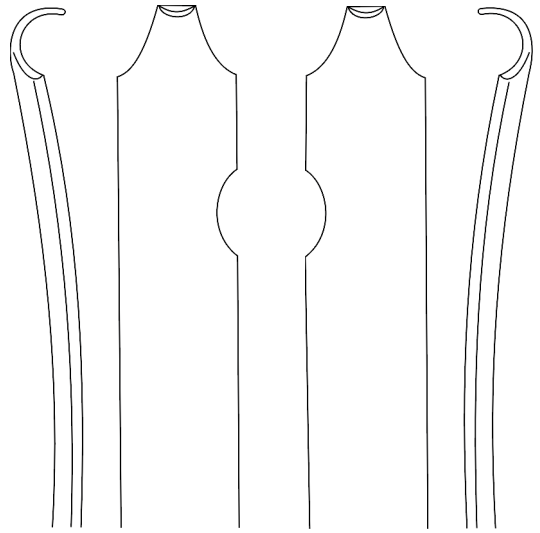
**Steinhauser**  
23 cm / 9"  
20 x 50 mm



**Hargis**  
**V-033-1040**  
 18.5 cm / 7 1/4"

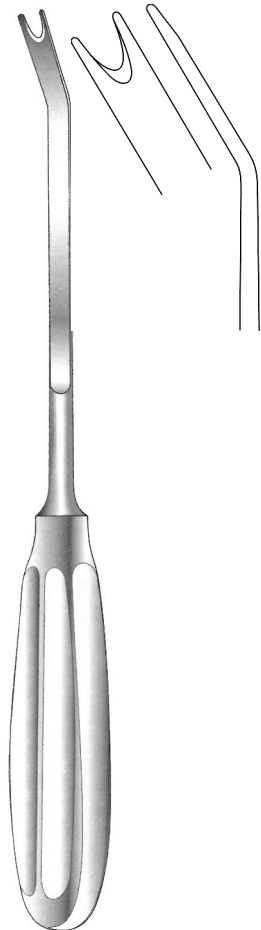


**Hargis**  
 19.5 cm / 7 3/4"

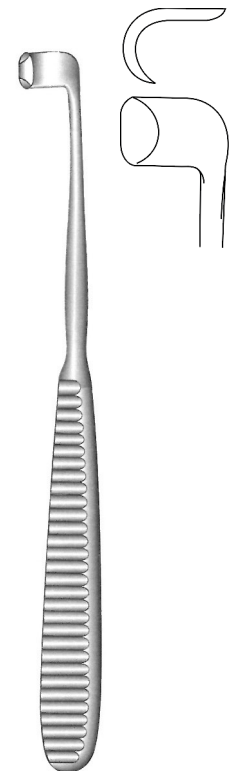


**V-033-1050**  
 Right

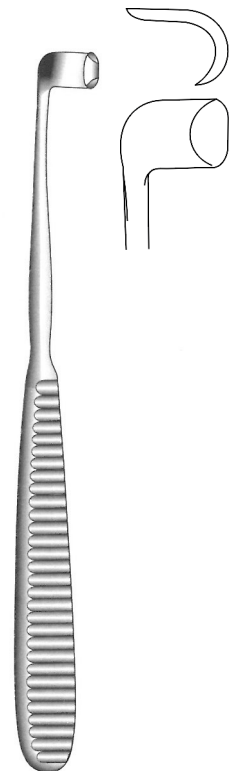
**V-033-1052**  
 Left



**Terry**  
**V-033-1060**  
 24 cm / 9 1/2"  
 Ramus pusher



**Obwegeser**  
**V-033-1070**  
 18 cm / 7"  
 10 mm  
 Angled to left



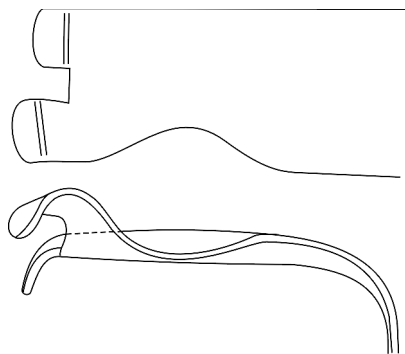
**Obwegeser**  
**V-033-1080**  
 18 cm / 7"  
 10 mm  
 Angled to right

# Crano Maxillo-Facial Surgery

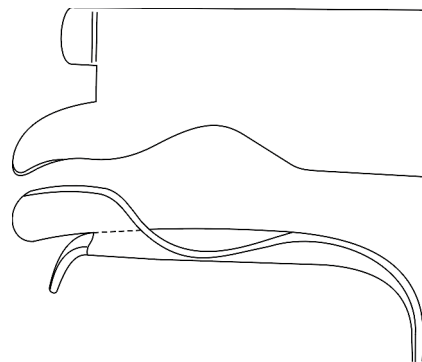
LeFort I Retractors, Sinus Lift Retractors

LeFort I-Haken, Sinushaken

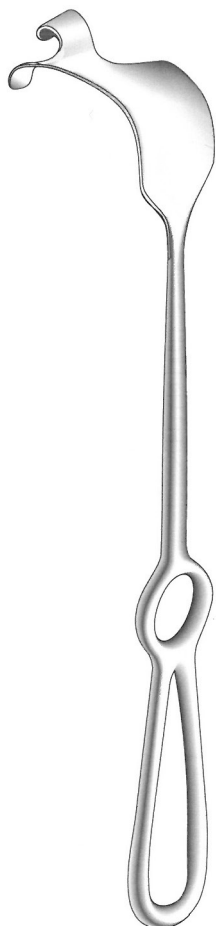
Ganchos de LeFort I, Ganchos para seno



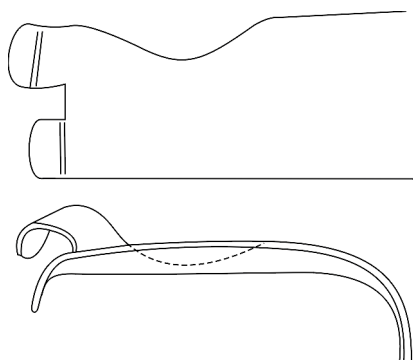
V-033-1090  
Left



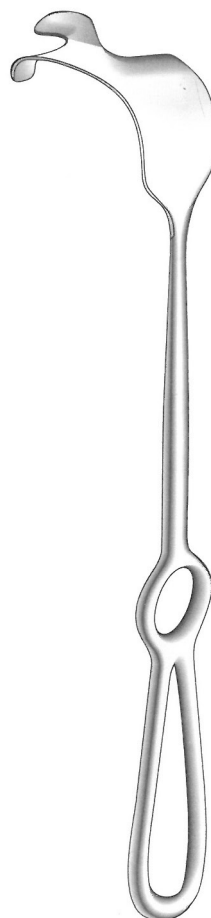
V-033-1100  
Left



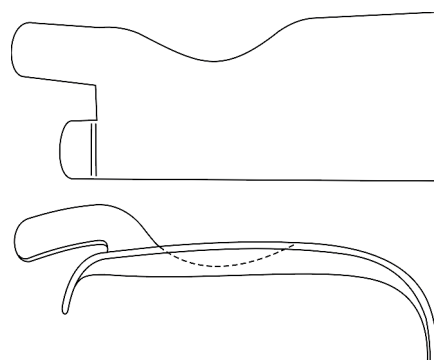
Arnhem  
22 cm / 8 3/4"  
LeFort 1 retractor



V-033-1092  
Right

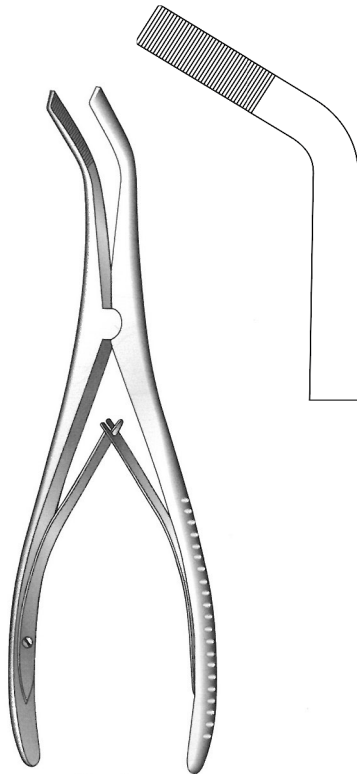


Arnhem  
22 cm / 8 3/4"  
Sinus lift retractor

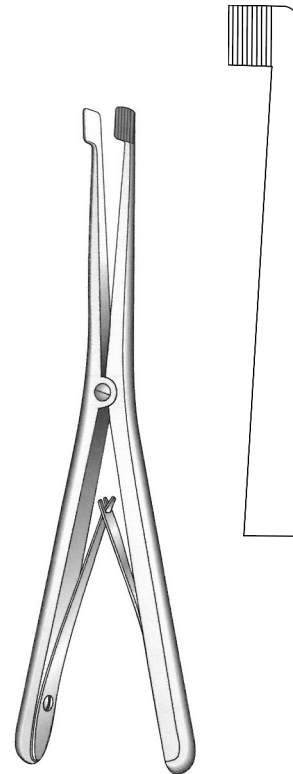


V-033-1102  
Right

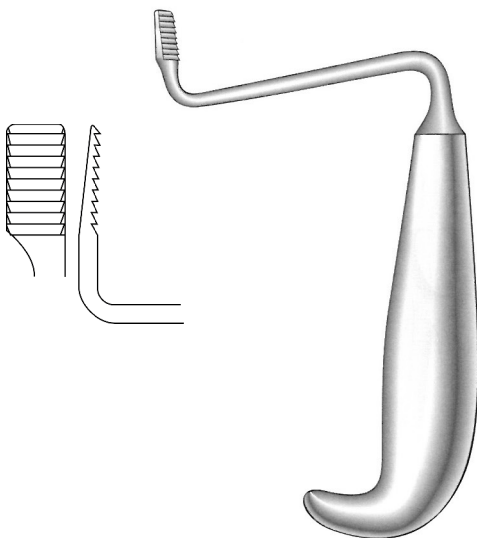




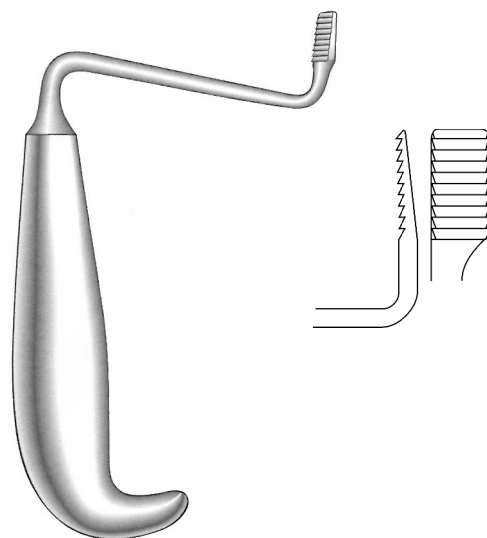
**Tessier**  
**V-033-1110**  
 17.5 cm / 7"  
 7mm  
 Spreading forceps



**Turvey**  
**V-033-1420**  
 17 cm / 6 3/4"  
 Palatal expander



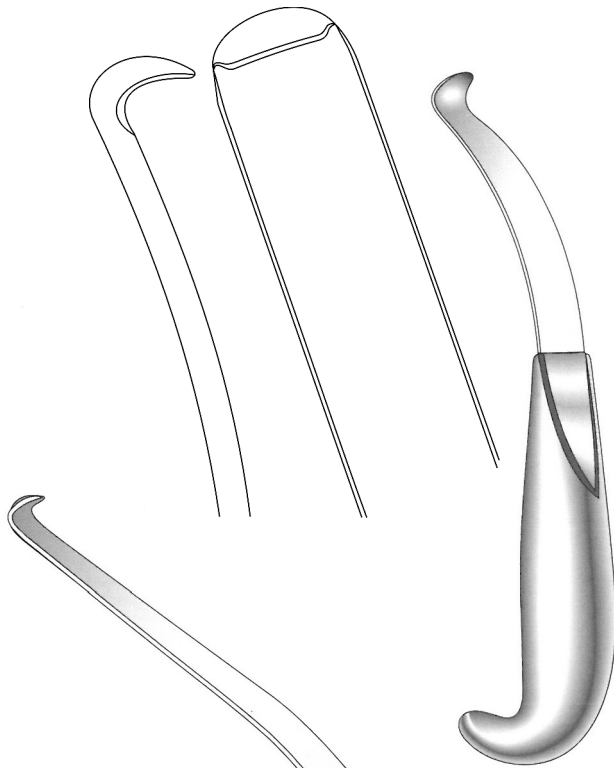
**Tessier**  
**V-033-1120**  
 15 cm / 6"  
 9 mm  
 Right



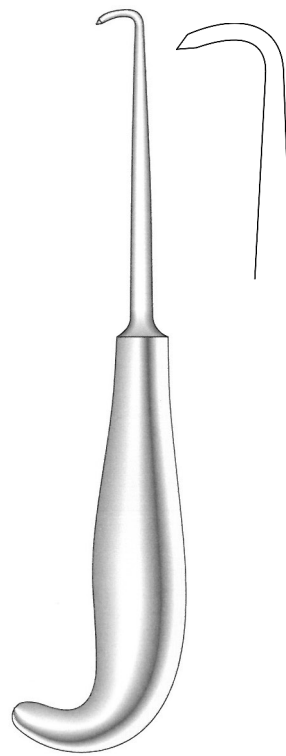
**Tessier**  
**V-033-1130**  
 15 cm / 6"  
 9 mm  
 Left

# Crano Maxillo-Facial Surgery

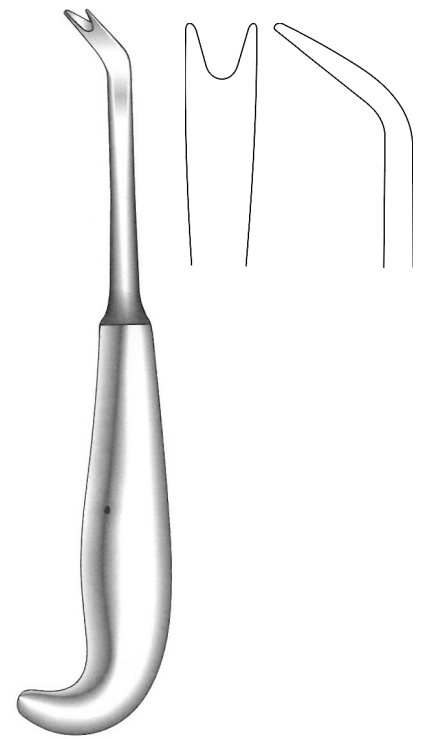
Mandibular Body Retractor, Anterior Border Stripper, Sagittal Split Separators  
 Unterkieferkorperhaken, Vorderrandstripper, Sagittalspreizer  
 Separador para el cuerpo mandibular Y el borde anteriore, para Sagitales



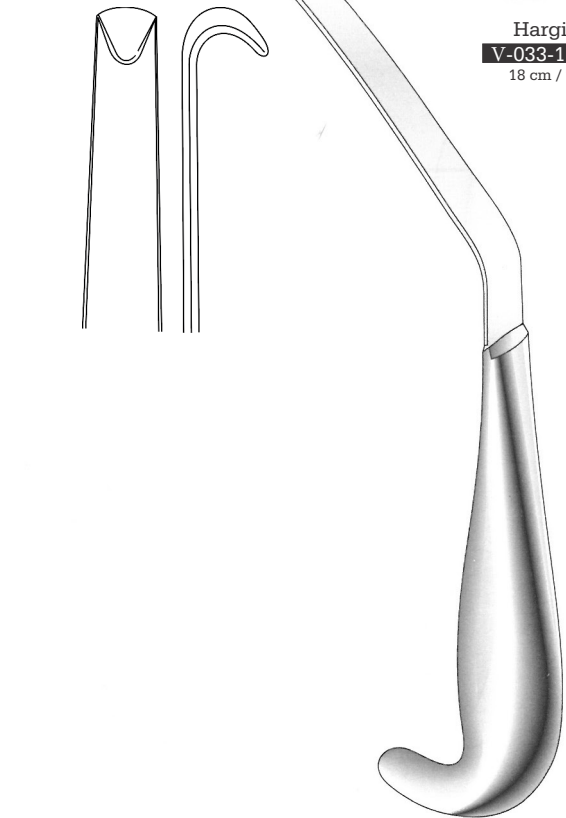
Hargis  
**V-033-1140**  
 18 cm / 7"



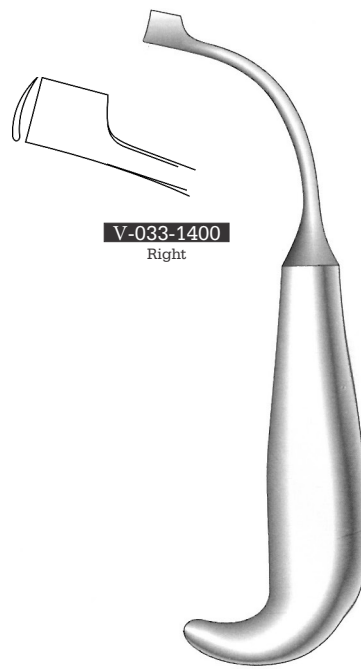
Dingmann Wilk  
**V-033-1150**  
 20 cm / 8"



Hargis  
**V-033-1160**  
 19 cm / 7½"

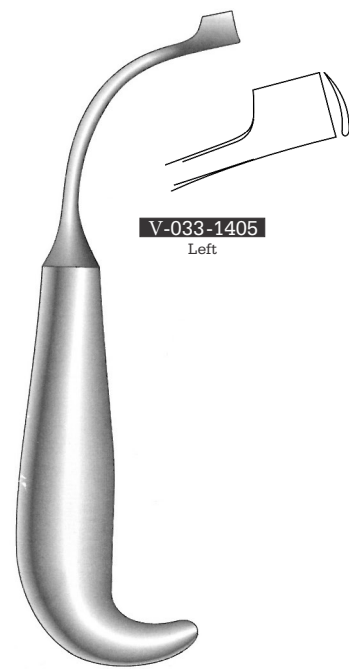


Steinhauser  
**V-033-1170**  
 27 cm / 10½"  
 Extra long channel retractor



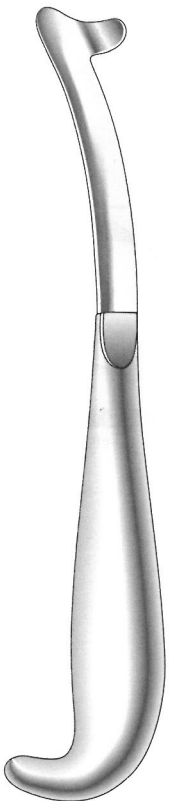
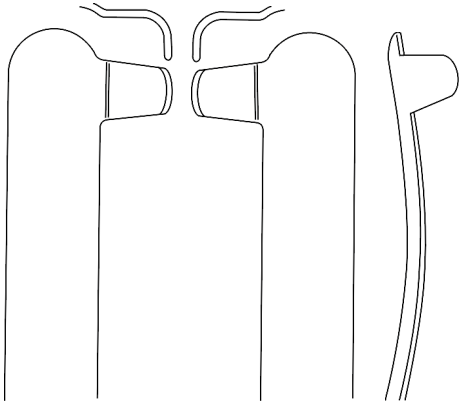
**V-033-1400**  
 Right

Smith  
 18.5 cm / 7¼"  
 9 mm

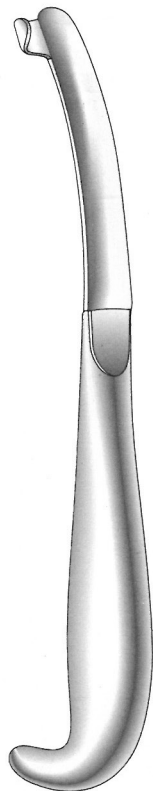


**V-033-1405**  
 Left

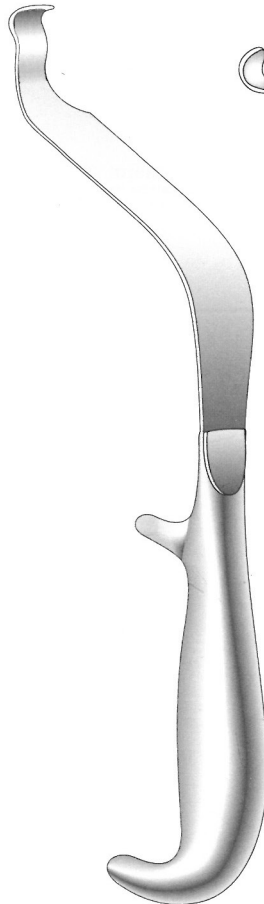
Smith  
 18.5 cm / 7¼"  
 9 mm



**V-033-1180**  
 21 cm / 8¼"  
 26.5 / 16 mm  
 Right



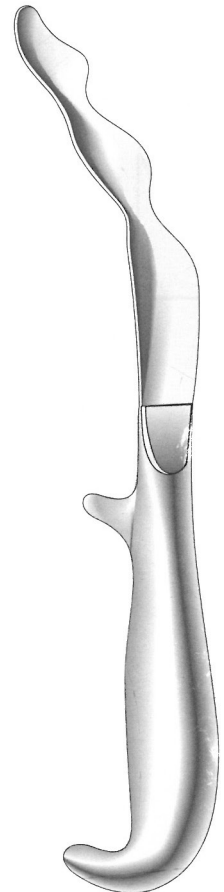
**V-033-1190**  
 21 cm / 8¼"  
 26.5 / 16 mm  
 Left



**V-033-1200**  
 25 cm / 9¾"  
 12.5 / 27 mm  
 L&M. for vertical osteotomy



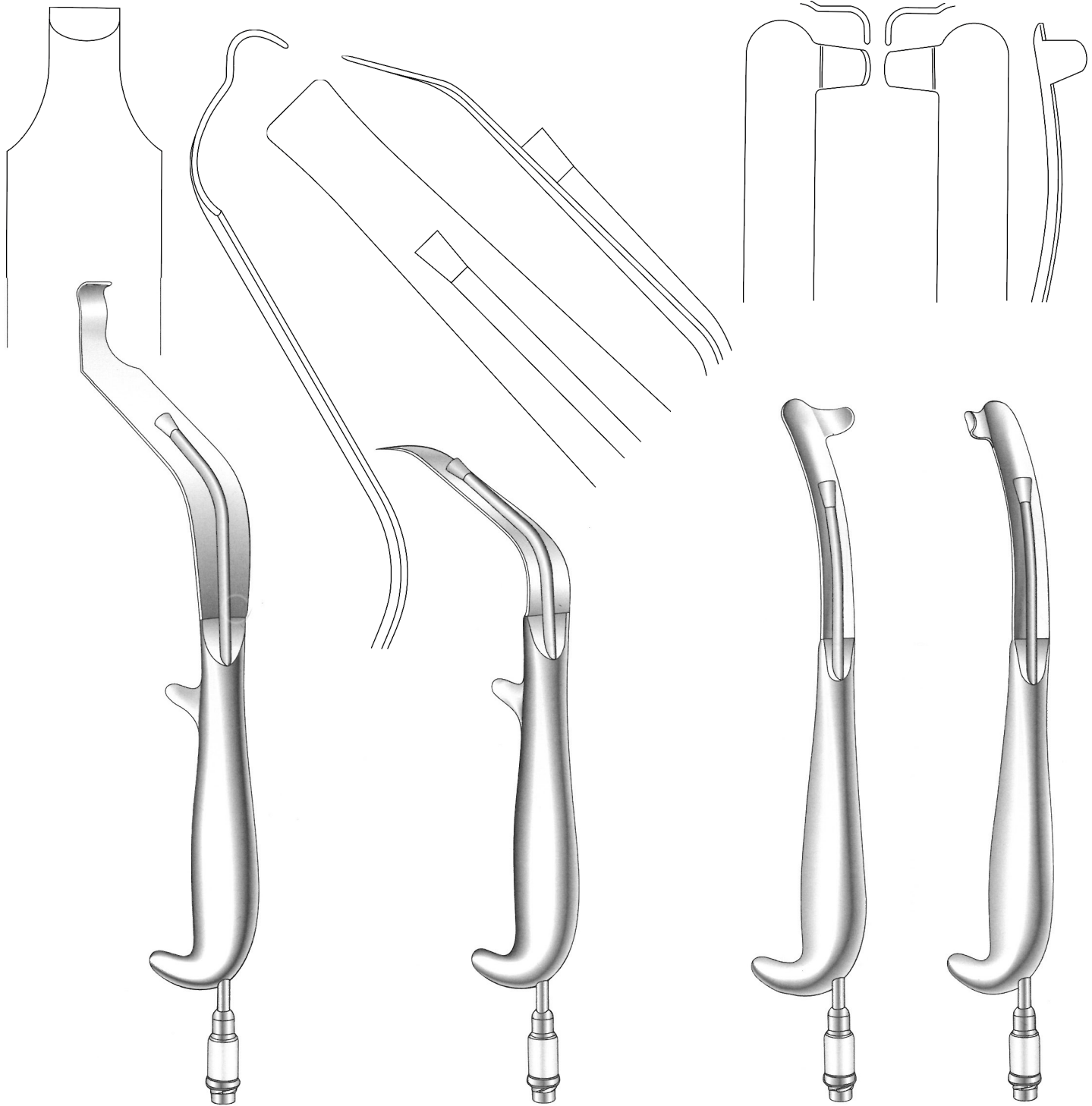
**V-033-1210**  
 22 cm / 8¾"  
 9.5 / 16 mm  
 Concave blade, fully bent tip  
 Extra oral retractor



**V-033-1220**  
 23 cm / 9"  
 25.5 mm  
 For LeFort osteotomies

# Crano Maxillo-Facial Surgery

Intra Oral Retractors  
Intraorale Retraktoren  
Separadores intra orales

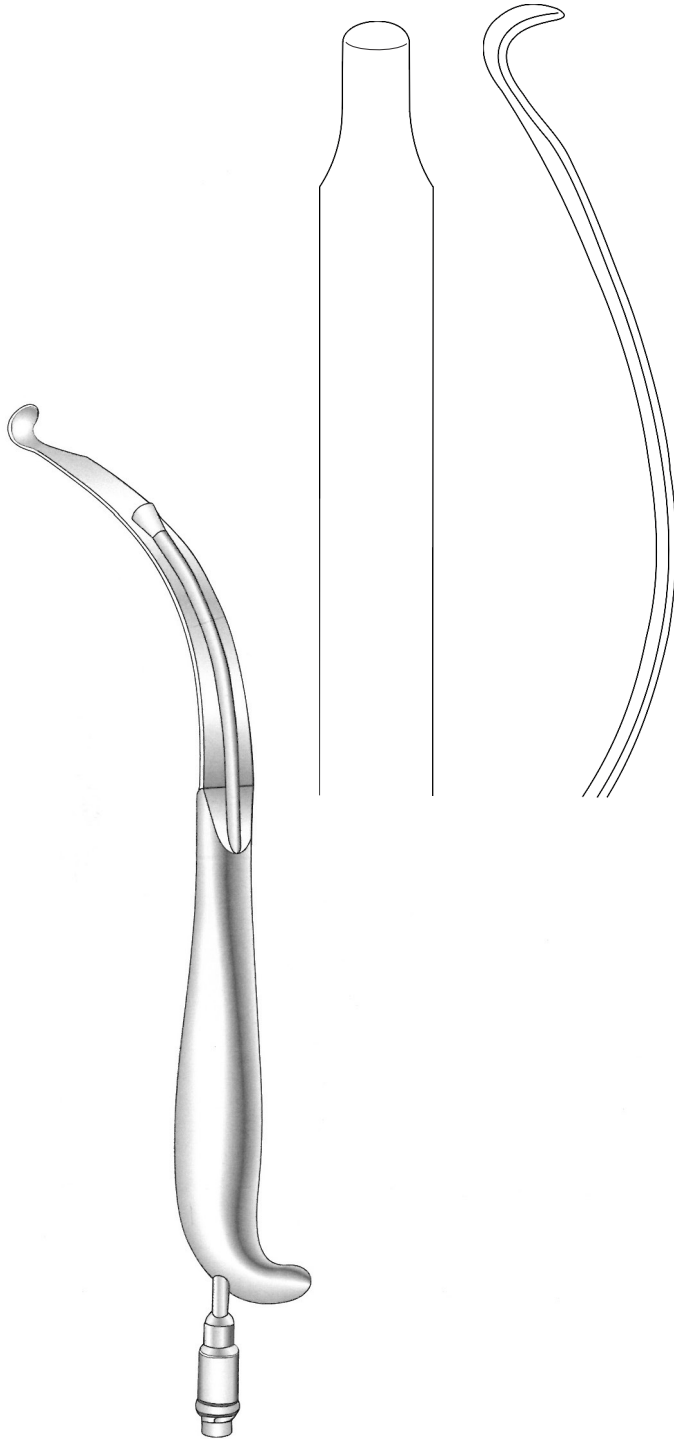


**V-033-1230**  
28 cm / 11"  
12.5 / 27 mm  
L&M, for vertical osteotomy  
with fiber optic light carrier

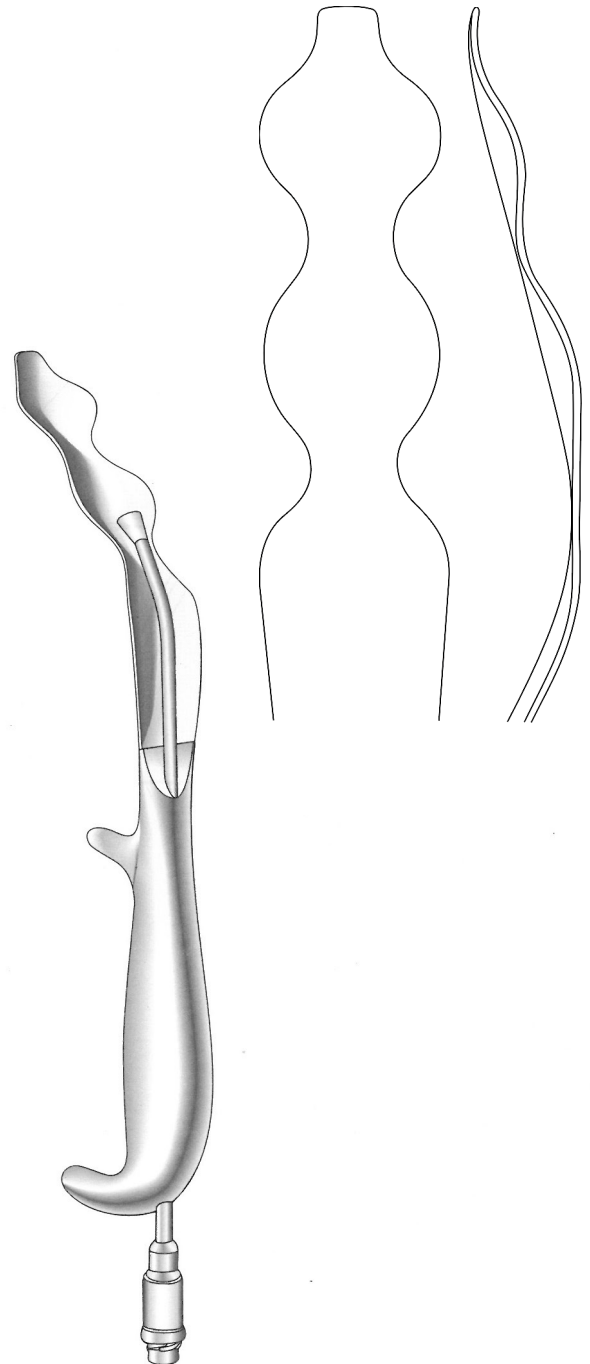
Shea  
**V-033-1240**  
22 cm / 8¾"  
14.5 mm  
Multi purpose retractor  
with fiber optic light carrier

**V-033-1250**  
24.5 cm / 9¾"  
26.5 / 16 mm  
Right  
with fiber optic light carrier

**V-033-1260**  
24.5 cm / 9¾"  
26.5 / 16 mm  
Left  
with fiber optic light carrier



**V-033-1270**  
 25.5 cm / 10"  
 9.5 / 16 mm  
 Concave blade, fully bent tip  
 Extra oral retractor  
 with fiber optic light carrier



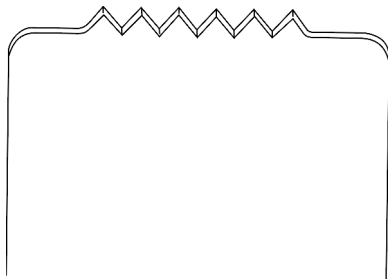
**V-033-1280**  
 27 cm / 10¾"  
 25.5 mm  
 For LeFort osteotomies  
 Intra oral retractor  
 with fiber optic light carrier

# Crano Maxillo-Facial Surgery

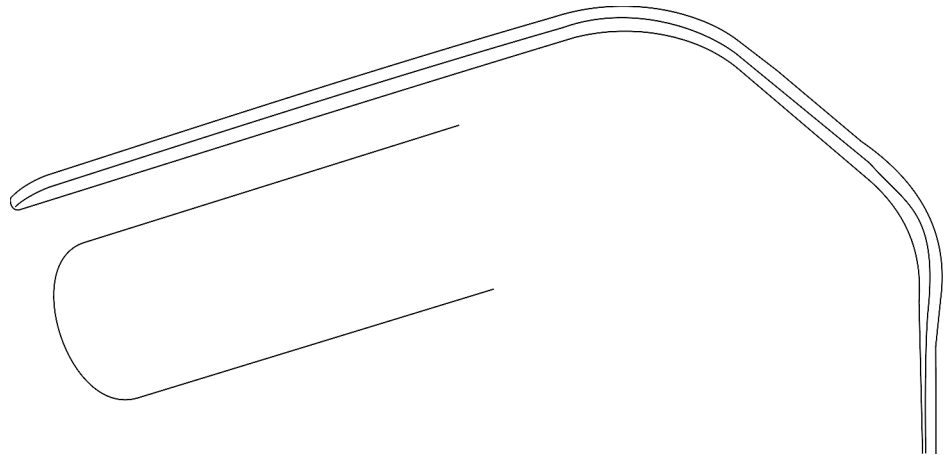
Iliac Crest Retractors, Thoracic Retractors

Beckenkammspatel, Thoraxhaken

Separadores para cresta iliaca, Separadores toracico



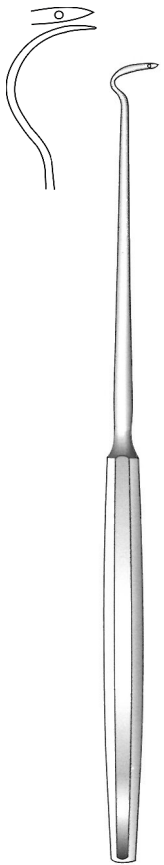
- V-033-1290 36 x 50 mm
- V-033-1292 52 x 50 mm
- V-033-1294 59 x 50 mm
- V-033-1296 66 x 50 mm



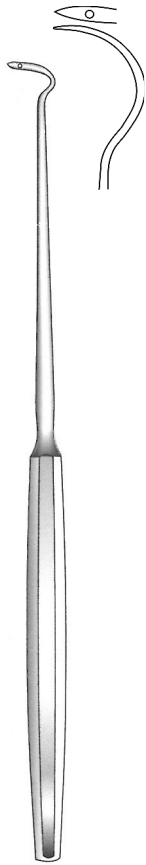
Tessier  
16 cm / 6 1/4"  
Black chromium plated



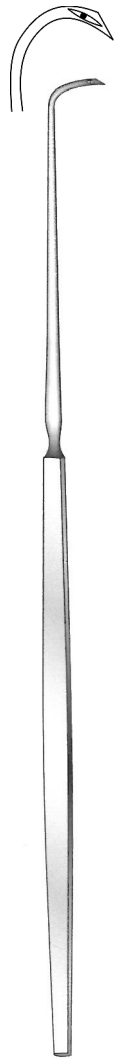
Tessier  
V-033-1300 90 x 22 mm  
V-033-1302 120 x 28 mm  
20.5 cm / 8"  
Black chromium plated



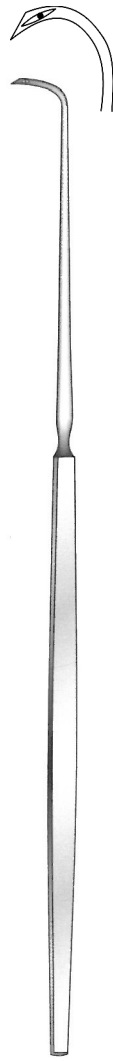
Hurd  
V-034-001  
21 cm / 8 1/4"  
For right hand



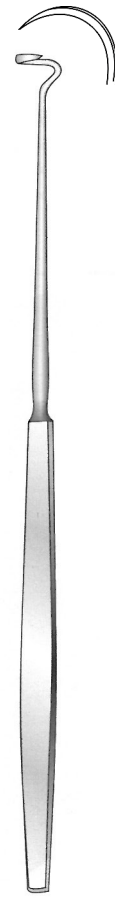
Hurd  
V-034-005  
21 cm / 8 1/4"  
For left hand



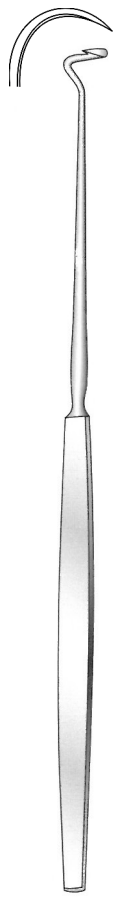
Durham  
V-034-020  
25 cm / 10"



Durham  
V-034-030  
25 cm / 10"



Dupuy-Weiss  
V-034-040  
22 cm / 8 3/4"



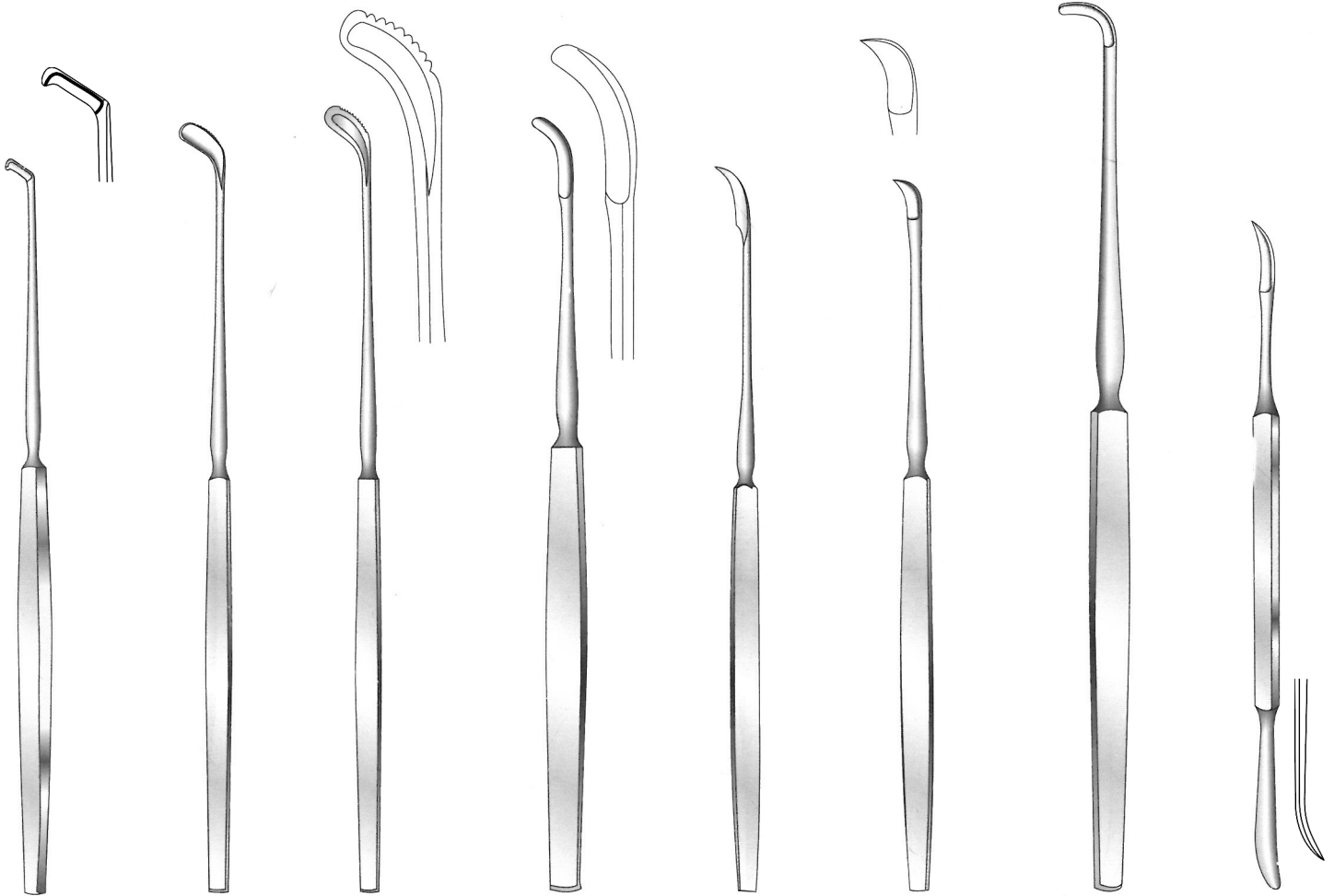
Dupuy-Weiss  
V-034-050  
22 cm / 8 3/4"

# Tonsil

Tonsil Knives

Tonsillennmesser

Bisturries para amígdalas



Douglas

**V-034-060**  
21 cm / 8¼"

Colver

**V-034-070**  
22.5 cm / 9"

Fisher

**V-034-080**  
22.5 cm / 9"

Day

**V-034-090**  
21.5 cm / 8½"

Abraham

**V-034-100**  
21.5 cm / 8½"

Canfield

**V-034-110**  
21 cm / 8¼"

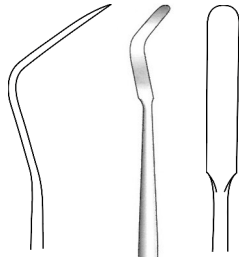
Tyding

**V-034-120**  
21 cm / 8¼"

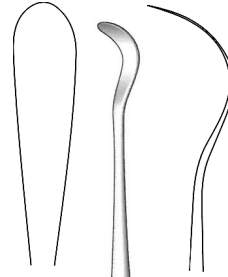
Lynch

**V-034-130**  
20 cm / 8"

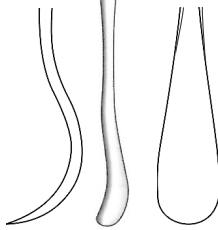
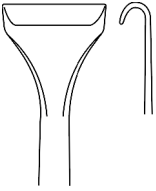




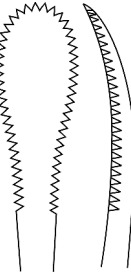
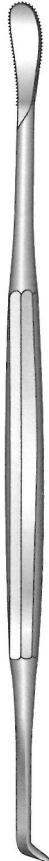
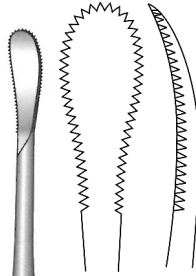
**Carpenter**  
**V-034-140**  
 22.5 cm / 9"  
 4.4/8.8 mm



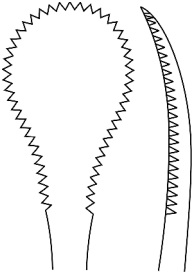
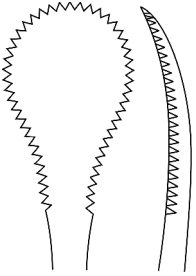
**Carpenter**  
**V-034-150**  
 22.5 cm / 9"  
 4.4/8.8 mm



**Hurd**  
**V-034-151**  
 23 cm / 9"  
 11/14 mm



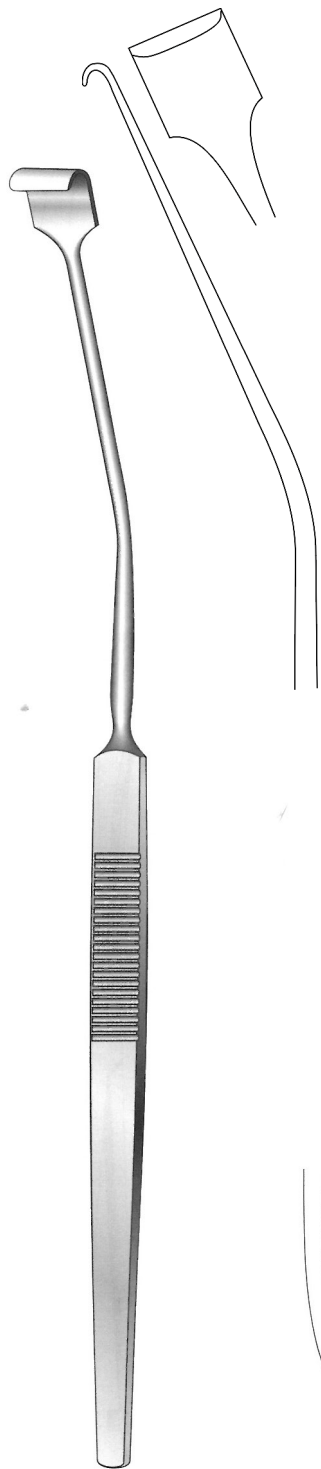
**Henke**  
**V-034-152**  
 23 cm / 9"  
 10.5/5 mm



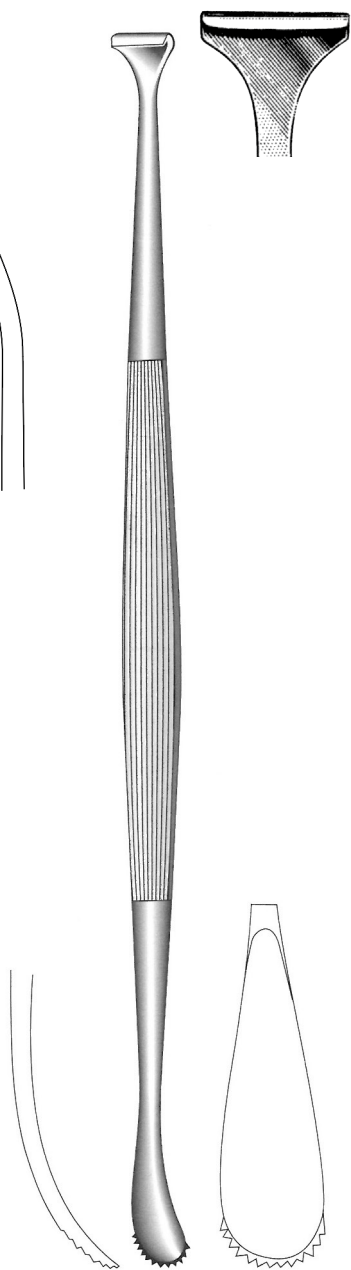
**Henke**  
**V-034-153**  
 23 cm / 9"  
 16/5 mm

# Tonsil

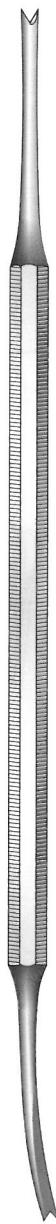
Dissectors, Retractors, Gauze Packers  
 Dissektoren, Wundhaken, Tamponstopfer  
 Discadores, Separadore, Taponeadores



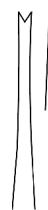
**Nager**  
**V-034-154**  
 24 cm / 9½"



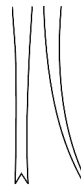
**Hurd**  
**V-034-156**  
 22 cm / 8¾"  
 10 x 12 mm wide  
 Throat retractors and dissector



**Luniatschek**  
 17.5 cm / 7"



**V-034-160**  
 2 mm



**V-034-161**  
 3 mm



**Luniatschek**  
 17.5 cm / 7"



**V-034-165**  
 2 mm  
 Round handle

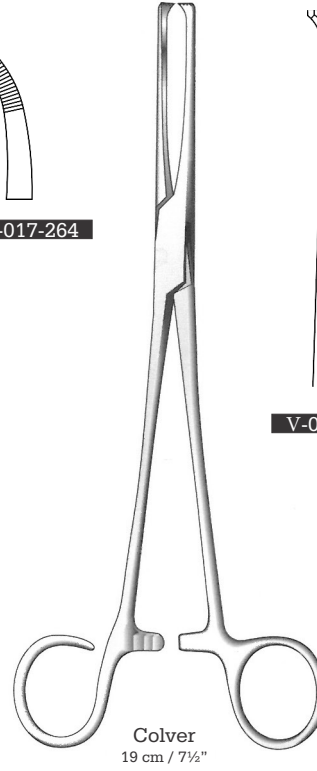




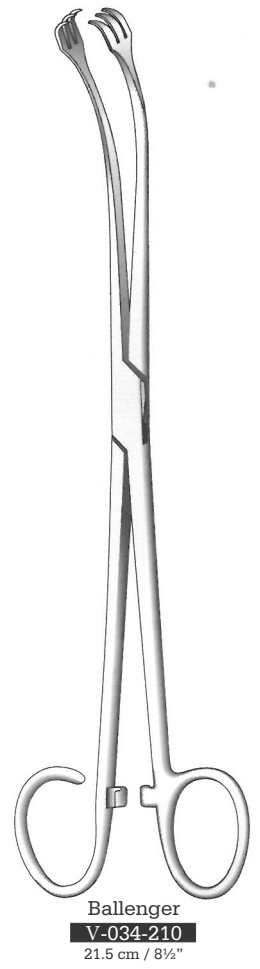
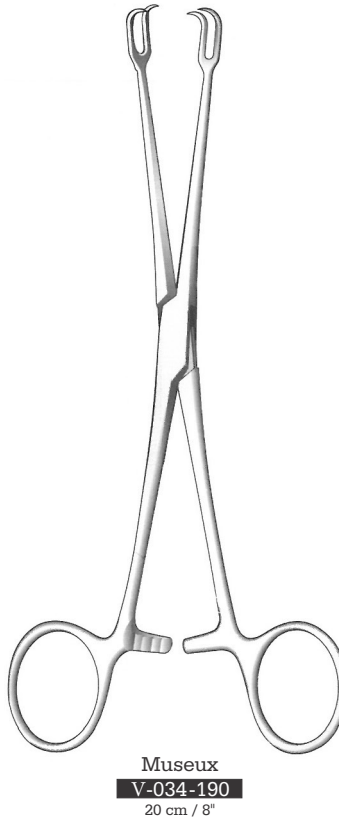
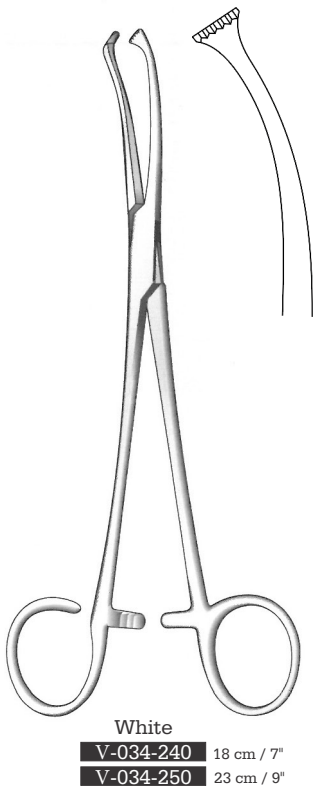
V-017-261 V-017-262



V-017-263 V-017-264



V-034-220 V-034-230

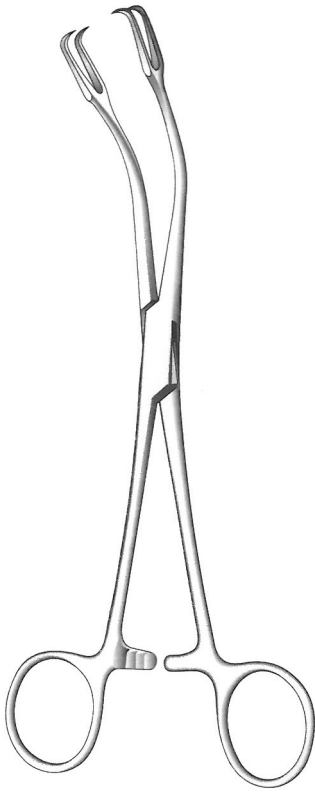


# Tonsil

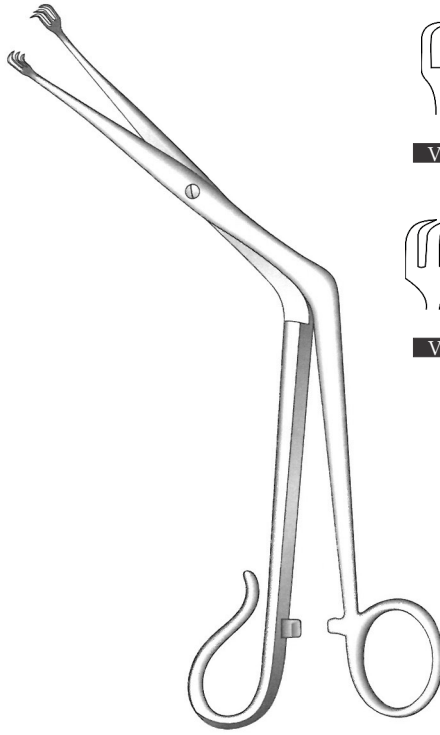
Tonsil Seizing Forceps

Tonsillenzangen

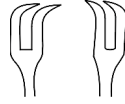
Pinzas para coger las amígdalas



Museux  
V-034-200  
20 cm / 8"



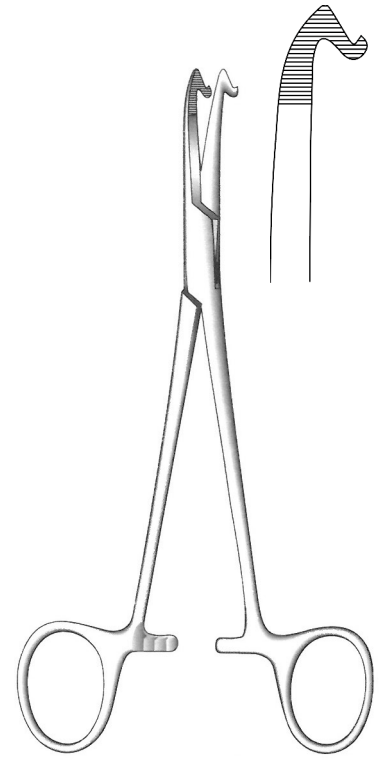
Tivnen-Tyding  
21 cm / 8 1/4"



V-034-180



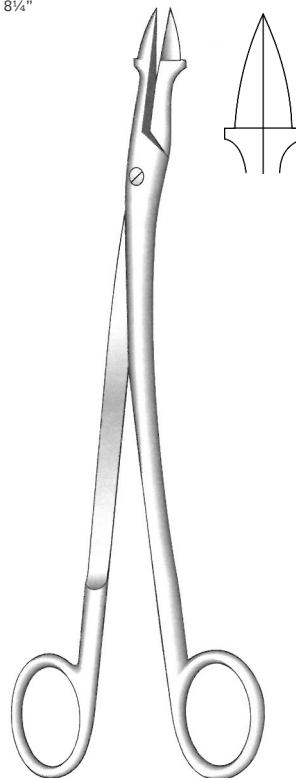
V-034-182



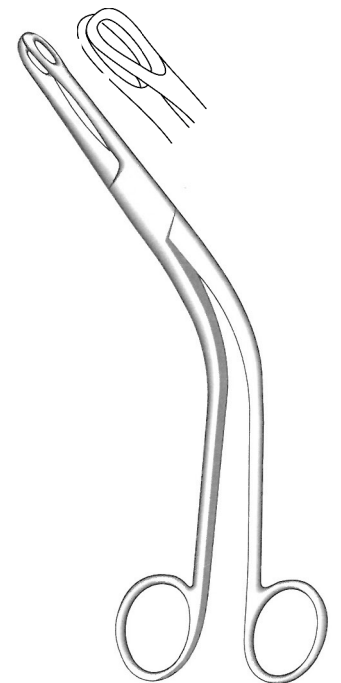
McWhorter-Lothrop  
V-034-300  
18 cm / 7"



Blohmke  
V-034-290  
20 cm / 8"



Thilenius  
V-034-280  
20 cm / 8"



Denis-Browne  
V-034-310  
18 cm / 7"



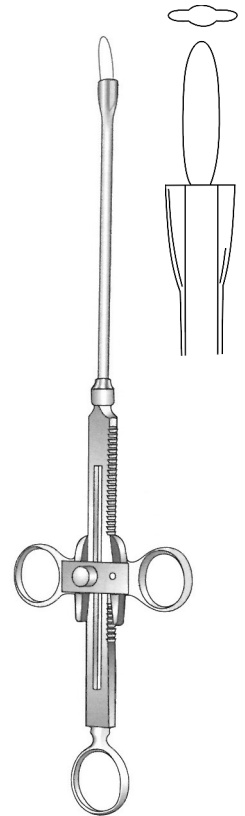
V-034-311  
0.3 mmØ



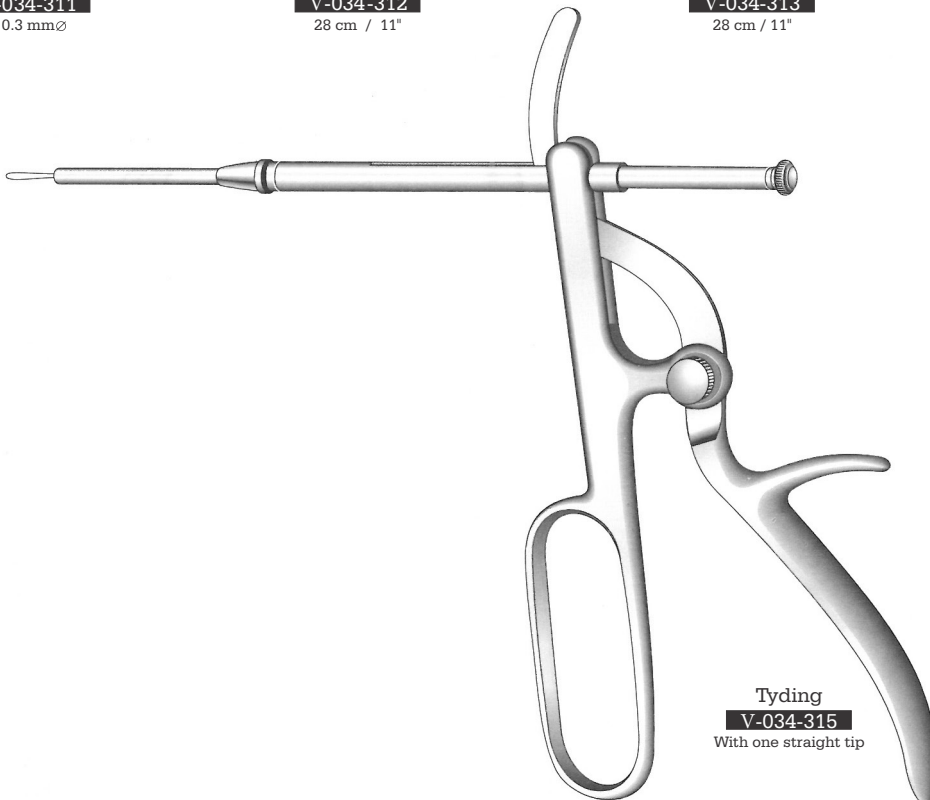
Eves  
V-034-312  
28 cm / 11"



Eves  
V-034-313  
28 cm / 11"



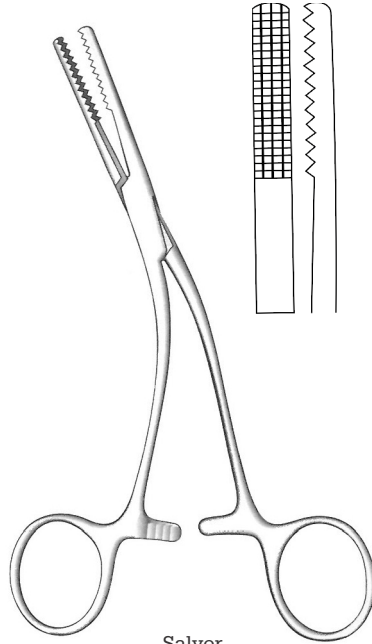
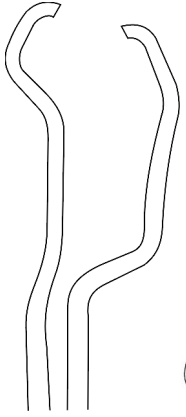
Bruenings  
V-034-314  
28 cm / 11"



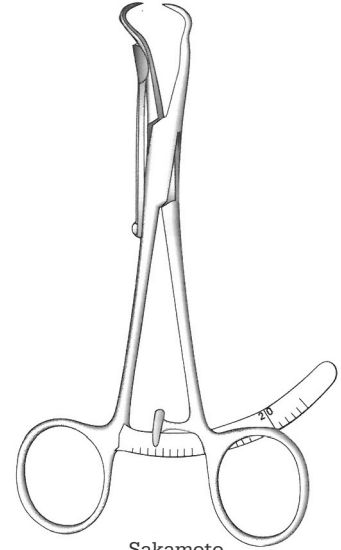
Tyding  
V-034-315  
With one straight tip

# Tonsil

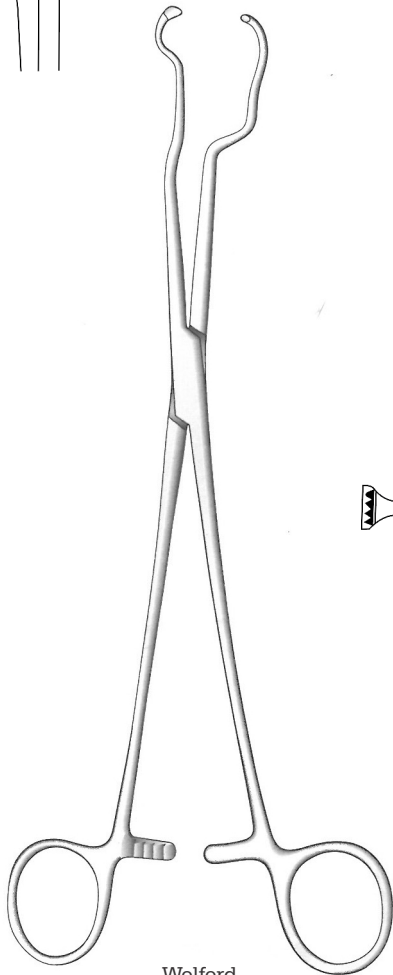
Bone Holding Forceps  
Knochenhaltezaugen  
Pinzas para huesos



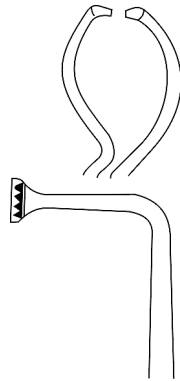
**Salyer**  
**V-034-1100**  
16 cm / 6½"



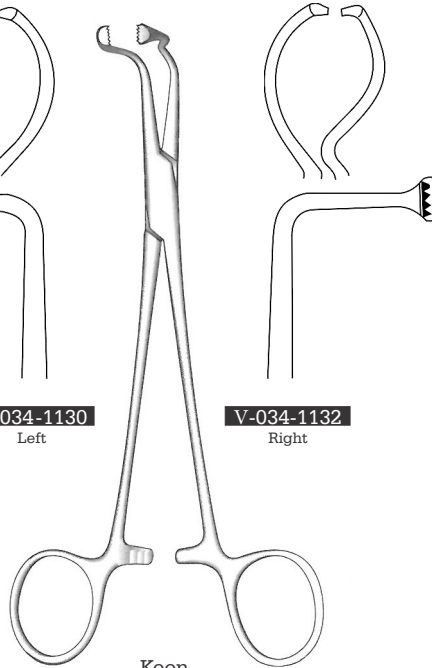
**Sakamoto**  
**V-034-1110**  
14 cm / 5½"  
Measuring forceps



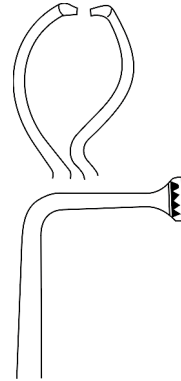
**Wolford**  
**V-034-1120**  
25 cm / 10"



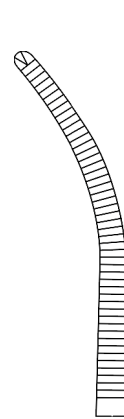
**V-034-1130**  
Left



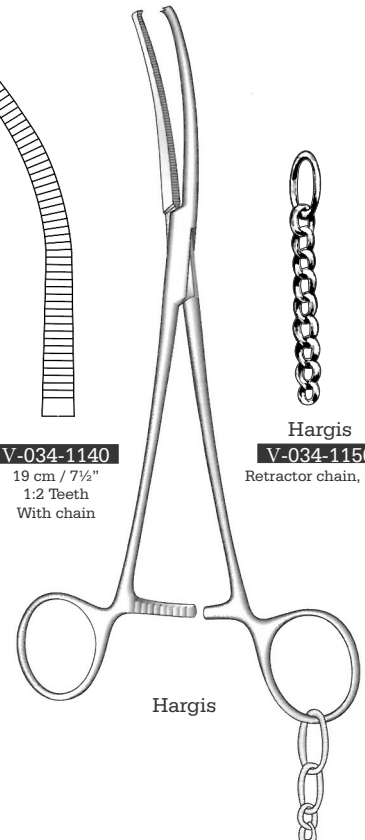
**Keen**  
17.5 cm / 6¾"



**V-034-1132**  
Right



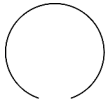
**V-034-1140**  
19 cm / 7½"  
1:2 Teeth  
With chain



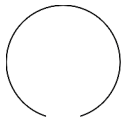
**Hargis**



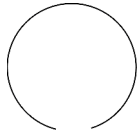
**Hargis**  
**V-034-1150**  
Retractor chain, only



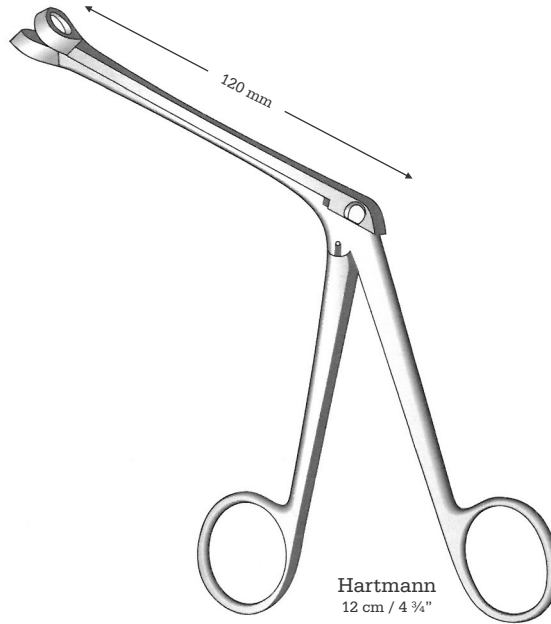
**V-034-316**  
13 mm  $\emptyset$   
Cut  
Through cut



**V-034-317**  
15 mm  $\emptyset$   
Cut  
Through cut



**V-034-318**  
17 mm  $\emptyset$   
Cut  
Through cut



**Hartmann**  
12 cm / 4 3/4"

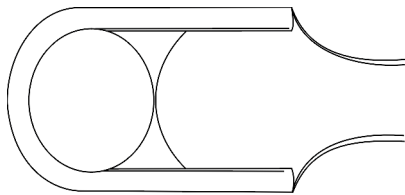


Fig. 1  
**V-034-319**  
Tip

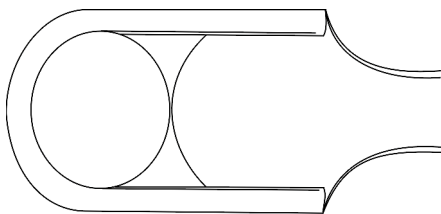


Fig. 2  
**V-034-320**  
Tip

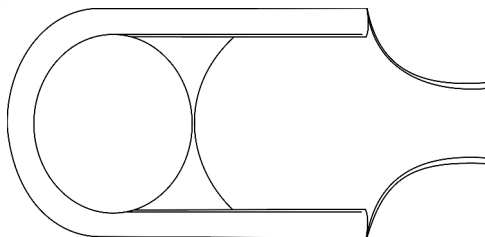
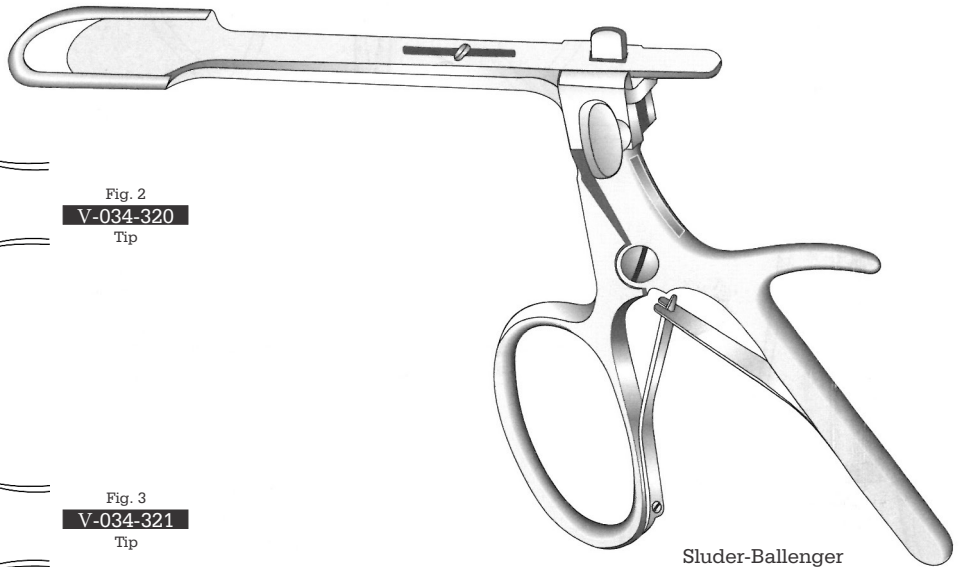


Fig. 3  
**V-034-321**  
Tip



**Sluder-Ballenger**  
**V-034-322**  
Complete set  
with 3 tips



Serving Healthcare Since 1971

## CONTACT US

Creative Industries Centre,  
Glaisher Drive Wolverhampton Science Park,  
Wolverhampton United Kingdom,  
WV10 9TG

**Email queries:**

[info@volmed.co.uk](mailto:info@volmed.co.uk) / [sales@volmed.co.uk](mailto:sales@volmed.co.uk)

[www.volmed.co.uk](http://www.volmed.co.uk)